

AN2731

Compact Planar Antennas for 2.4 GHz Communication

Designs and Applications within NXP EVK Boards

Rev. 4 — 11/2020

Application Note

by: NXP Semiconductors

1 Introduction

With the introduction of many applications into the 2.4 GHz band for commercial and consumer use, antenna design has become a stumbling point for many customers. Moving energy across a substrate using an RF signal is very different than moving a low frequency voltage across the same substrate. Therefore, designers who lack RF expertise can avoid pitfalls by simply following good RF practices when designing a board layout for IEEE 802.15.4 and Bluetooth low energy applications. The design and layout of antennas is an extension of that practice. This application note provides that basic insight on board layout and antenna design to improve the customer first pass success.

Antenna design is a function of frequency, application, board area, range, and costs. Whether your application requires the absolute minimum costs or minimization of board area or the maximum range, it is important to understand the critical parameters so that proper trade-offs can be chosen. Some of the parameters necessary to select a correct antenna are antenna tuning, matching, gain/loss, and required radiation pattern.

This document is not an exhaustive inquiry into antenna design. It is instead focused on helping the customers understand enough board layout and antenna basics to select a correct antenna type for their application, as well as avoiding typical layout mistakes that cause performance issues that lead to delays. Additionally, several popular antennas are presented as possible solutions for some of the IEEE 802.15.4 and Bluetooth low energy applications.

2 Antenna terms

Table 1 lists the antenna terms.

Table 1. Antenna terms

Term	Description
Antenna gain	A mathematical measure of an antenna radiation pattern compared to a reference antenna, such as a dipole or an isotropic radiator. The gain is usually measured in dBS relative to a dipole or dBi relative to an ideal isotropic. In any given direction, negative gain means that the antenna radiates less than the reference antenna and a positive number means that the antenna radiates more than the reference antenna.
Decibel (dB)	A logarithmic scale that represents power gain or loss in an RF circuit. 3 dB represents double power, -3 dB is half the power and -6 dB represents half the voltage or current, but a quarter of power.

Table continues on the next page...

Contents

1	Introduction.....	1
2	Antenna terms.....	1
3	Basic antenna theory.....	3
4	Impedance matching.....	4
5	Antennas.....	6
6	Miniaturization trade-offs.....	8
7	Potential issues.....	9
8	Recommended antenna designs....	9
9	Design examples (antennas on the NXP EVK boards).....	10
10	Other antenna designs (custom made).....	34
11	Conclusion.....	46
12	Revision history.....	47



Table 1. Antenna terms (continued)

Term	Description
Decibel-isotropic (dBi)	Application of the logarithmic scale to antenna gain that is relative to an ideal isotropic antenna.
Radiation resistance	The real part of an antenna's impedance that is associated with radiated power.
Antenna efficiency	It is the ratio of the power radiated to the power delivered to the antenna input. Hence, an antenna with 50 % efficiency has a ratio of 0.5 or -3 dB. Total efficiency includes antenna efficiency and also accounts for mismatch losses.
Antenna polarization	All the radio waves are made of electric and magnetic fields. The electric and magnetic fields are mutually perpendicular, and both are also perpendicular to the direction of propagation. The oscillation direction of the electric field component is called the polarization of the radio wave (when a radio wave is propagating in a medium).
Linear antenna polarization	When the electric field oscillates in the vertical or horizontal direction the radio wave is called to be linearly polarized.
Circular antenna polarization	When the polarization of a radio wave rotates while the signal propagates, the radio wave is called to be circularly polarized. The direction of the signal rotation classifies two types of circular polarization: Right-Hand Circular Polarization (RHCP) and Left-Hand Circular Polarization (LHCP). A circularly polarized signal consists of two perpendicular electromagnetic plane waves of an equal amplitude, which are 90 degrees out of phase.
VSWR	Voltage Standing Wave Ratio - the parameter VSWR numerically describes how well the antenna is impedance-matched to the radio or transmission line it is connected to.
Transmission lines	A physical means to transport RF signal from one point to another, which is defined by its physical constraints to match the characteristic impedance of the system. Most common systems use 50 Ohms characteristic impedance.
Microstrip	A type of electrical transmission line that can be fabricated using printed circuit board technology and used to convey microwave-frequency signals. It consists of a conducting strip separated from a ground plane by a dielectric layer known as the substrate.
Stripline	A type of electrical transmission line that can be fabricated using printed circuit board technology and used to convey microwave-frequency signals. It consists of a flat strip of metal that is sandwiched between two parallel ground planes. The insulating material of the substrate forms a dielectric. The width of the strip, the thickness of the substrate, and the relative permittivity of the substrate determine the characteristic impedance of the strip, which is a transmission line.

Table continues on the next page...

Table 1. Antenna terms (continued)

Term	Description
Coplanar waveguide (CPW)	The “classic” Coplanar Waveguide (CPW) is formed by a conductor separated from a pair of ground planes, all on the same plane, atop a dielectric medium. In the ideal case, the thickness of the dielectric is infinite. A variant of coplanar waveguide is formed when a ground plane is located beneath the transmission line against the substrate.
Characteristic impedance	Usually written as Z_0 , it is the ratio of the amplitudes of voltage and current of a single wave propagating along a transmission line travelling in one direction.
Mismatch loss	The amount of power expressed in decibels that is not available on the output due to impedance mismatches and signal reflections.
Resistive loss	The component of the power loss, expressed in decibels, due to ohmic voltage reduction as a wave travels along a transmission line.

3 Basic antenna theory

A common method to evaluate an antenna is to view its antenna gain pattern. An antenna's gain pattern is a measure of directionality of the antenna. A perfect theoretical omni-directional antenna radiates equally in all directions and its field would look like a perfect sphere. However, practical manufacturable antennas cannot be made to radiate equally in all directions. Therefore, all practical antennas have some gain. The higher the gain, the more directional the antenna. Large distance fixed position applications actually require a highly directional antenna, whereas a general purpose local area network usually requires an antenna that is omni-directional.

Theoretically, any metallic structure can be used as an antenna. However, some structures are more efficient in radiating and receiving RF power than others. Transmission lines are used to convey the signal between the radio and the antenna with the minimum loss due to resistive, mismatch, and radiative losses as possible. The following examples explain these concepts.

Transmission lines take on a variety of shapes such as microstrip, coplanar waveguide, stripline, coaxial lines, and so on. For the IEEE 802.15.4 and Bluetooth low energy applications built on FR4 substrates, the methods of transmission lines typically take the form of a microstrip or Coplanar Waveguide (CPW). These two structures are defined by the dielectric constant of the board material, the line width, the board thickness between the line and the ground, and additionally for CPW, the gap between the line and the top edge ground plane. These parameters are used to define the characteristic impedance of the transmission line that is used to convey the RF energy between the radio and the antenna.

Typically, the RF ports from the IEEE 802.15.4 radios and Bluetooth low energy applications are differential or balanced. These ports RF impedances at the radio are in the range of 100 Ω . NXP's applications typically use a balun to transform the balanced signals to a single ended output with a characteristic impedance of 50 Ω . Therefore, NXP recommends an antenna with a 50- Ω feed.

The typical network for an IEEE 802.15.4 radio and Bluetooth low energy application includes a matching network between the radio ports (typically differential RF ports) and the antenna. To minimize the loss and simplify the matching, a balun is typically employed with NXP's application boards with component matching between the balun and the radio on the differential side of the balun. Then, to suppress any 2nd harmonic spurious in the spectrum, a 2nd harmonic trap is placed between the balun and the antenna on the single-ended side of the balun. The transmission lines on the differential side of the balun are usually high-impedance but short in length and therefore, they are sized more for manufacturing optimization than for RF performance with little impact on performance. The balun is essentially a transformer that can be chosen at various ratios of 1:1, 2:1, or 4:1 for optimum matching. The 2nd harmonic trap consists of a high-Q capacitor for the minimum loss, which is used to series resonate with its self inductance along with the board via the inductance at the 2nd harmonic or approximately 4900 MHz. This resonance presents an RF short at the second harmonic shunting most of the unwanted signal to ground. The trap capacitor increases the

loss at the fundamental frequency. This fundamental frequency loss can be minimized in two ways. Firstly, by adding inductance to the self-inductance of the capacitor. This allows the capacitor to resonate using a lower value capacitor. The lower the value of the capacitance, the lower the impact to the fundamental frequency loss. Secondly, by creating an open tank circuit that resonates at the fundamental frequency (2445 MHz). This is accomplished by placing an inductor in parallel to the shunt trap capacitor that together has a 2445 MHz open circuit resonance.

The antenna structure should be a reasonable size compared to the wavelength of the RF field. The natural size is half the wavelength. A half wavelength corresponds to approximately 6 cm (in air) in the 2.4 GHz ISM band. This size is effective, because when it is fed with RF power at the center point, the structure is resonant at the half wave frequency. Reducing the size below the natural resonant length can cause low efficiency. Not all structures make an efficient antenna.

Numerous structures that provide good efficiency and good impedance match have been devised, but most of these are derived from a few basic structures. A short description of the basic antennas recommended by NXP and some advice on how to implement these successfully is provided later on in this document. It is beyond the scope of this document to include complicated formulas concerning antenna theory. This note provides basic information about antennas, which enables users to achieve reasonable performance with few sample antennas.

Users interested in optimizing antenna performance by complex calculations and antenna simulations should consult the abundant and widely available literature concerning antenna theory and design. Usually, copying the NXP existing design should ensure reasonable performance. However, many factors affect the performance, such as antenna type, matching impedance, antenna gain (directionality), substrate thickness, substrate dielectric constant, and antenna efficiency.

4 Impedance matching

4.1 Radio to antenna

The best chance for customer first-pass success is to copy NXP's reference designs verbatim. However, some applications require a substrate with a different layer count or different thickness than what is recommended. Sometimes space is not available for a printed antenna or components from application circuitry may be adjacent to the RF area. Often the product plastic encapsulation interferes with performance.

There are important aspects of the board layout that must be followed if the customer is to achieve maximum performance from the radio. That includes making sure that no metal is under or around the antenna that is not called out in NXP reference designs. In addition, a common mistake is to run traces under the RF section on layer 2 ground, thereby cutting the ground reference plane that the RF traces require to maintain the designed impedance. All of these errors cause the radio to be loaded or the return loss to be high. If that happens, the signal that is to be transported to the antenna for radiation is instead reflected back into the radio. Therefore, it is just as critical to pay the same attention to the matching network layout as to the antenna design.

A good practice is to review all components in the RF section of a layout and remove all excess metal; that is, the metal that "fills in" around the components and around the radio IC pins. In addition, avoid routing of lines near or parallel to the RF transmission lines or RF bias lines. RF signals couple to these pieces of metal, which are usually connected to ground and therefore distort the signal causing excessive VSWR. As mentioned before, avoid any routing on the ground layer that would result in cutting the ground under the RF line. Maintaining a continuous ground under an RF trace is critical to maintain the characteristic impedance of that line. The recommended stackup is as follows: starting at the top: top - RF routing of transmission lines, L2 - Ground, L3 - DC routing, Bottom - DC routing.

Although there are antennas capable of matching to differential impedance, this application note is restricted to single-ended or unbalanced matching. This is further restricted to antennas with a feed impedance of 50 Ohms. The goal is to have an antenna on the Printed Circuit Board (PCB) that has $50 + i0 \Omega$ as its matching impedance. In this way, the antenna acts as a 50- Ω load to the output of the radio that feeds it. Therefore, the matching (when done properly) loads the radio's differential ports to obtain maximum power, minimum RX sensitivity, and minimum distortion of the radio signal, while moving the signal with the minimum loss between the antenna and the radio.

Antennas can be heavily loaded (increased VSWR) when placed in close proximity to ground. The close proximity to ground affects radiation resistance, which then can cause the match to deviate considerably from 50 Ohms, which in-turn translates to a poor match further down the matching network to the radios' output.

During the layout of the board, make provisions to allow for the measurement of the antenna VSWR. Even though you may copy the antenna shape exactly as prescribed by NXP, the material parameters may differ enough to cause the antenna to shift in frequency. If that occurs, it may not matter that the part is tuned for maximum power as most of it is reflected back into the radio if the VSWR is high. To avoid that, measure the antenna as one port and tune it by trimming or adding metal to it to center the minimum VSWR in the band. This approach only controls one parameter of the VSWR and does nothing for the gain or efficiency. That must be addressed by the design. If your application requires a different stackup or material properties or adjacent components that may distort the RF response, add a millimeter to the antenna length and plan on trimming to achieve acceptable return loss (-10 dB or less).

4.2 Antenna to 50 Ω

Three methods may be employed to measure the antenna separate from the matching network: RF microswitch, alternate path to an SMA connector (as found on NXP's MC13233-MRB), or a pigtail made from a coax soldered to the board.

1. An RF microswitch has been used on some NXP's reference designs where the method to evaluate either the antenna or the radio performance is a special connector that snaps onto the microswitch. The microswitch placement is after all matching and filtering but before the antenna. The special connector is connected to an SMA connector via a microcoax cable. The limitations are that the switch is directional and a determination must be made in advance of which direction the switch throws when the special connector is attached. That is, it can be "looking" into the output of the radio when the special connector is inserted or it can be "looking" into the antenna but not both. A limited number of boards can be built for each direction so that both the RF output of the radio and also the input of the antenna can be evaluated.
2. Microstrip to SMA. For the customers to evaluate some of NXP's boards without having to do the over-the-air measurements, a microstrip line is included to a board edge SMA connector. The microstrip is selectable from the single-ended side of the balun on the antenna side of the harmonic trap (which is usually between the balun and the antenna). The microstrip line is selectable using a capacitor rotated towards the SMA instead of towards the antenna. In that case, if you are careful in the placement of the capacitor instead of selecting between an RF output path of either the SMA connector or the antenna from the radio, the capacitor can be placed across the connection of the SMA and the antenna. In that case, the SMA can be used to interrogate the VSWR of the antenna without any special connectors or special preparation of the board, as required when employing the third method.

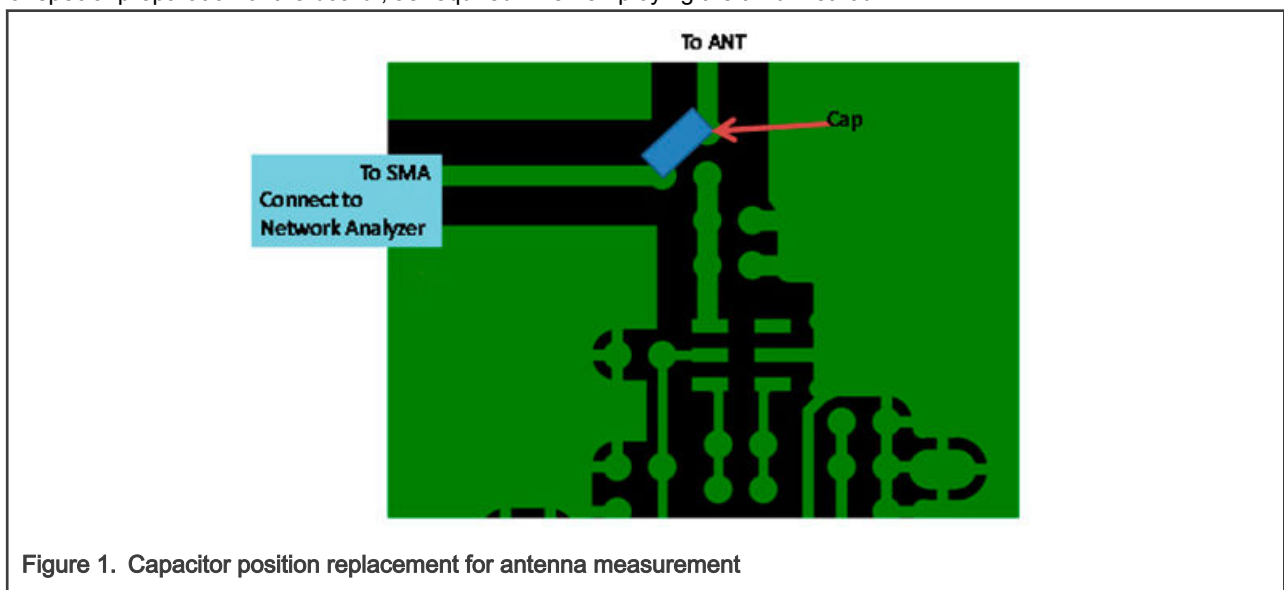

Figure 1. Capacitor position replacement for antenna measurement

3. Pigtail. Often customers do not want to incur the cost of a special microcoax connector and microswitch when only a few are needed for the validation of design. When it is not convenient to include an alternate path for the SMA for their specific application. In this case, if a sufficient ground plane is available and the customer is careful to keep the components clear, a piece of coax cable with an SMA connector on one end can be soldered to the board on the ground plane and the center pin can be attached to the antenna feed. This method does not lend itself when you produce many boards, but it is useful when you tune and evaluate only a few boards. If a lot of boards is necessary for design validation, methods 1 or 2 are recommended.

The most common antenna is an inverted F antenna. This section describes how to tune an inverted F antenna feed impedance to achieve 50-Ohm characteristic impedance. It is a simple matter to tune an inverted F antenna to operate at a proper frequency. Ideally, the minimum return loss must be centered at about 2445 MHz. If the frequency is offset a little (such that there is at least 10 dB return loss looking into the antenna at the band edges) it is sufficient to achieve good range and receiver sensitivity. Using one of the three methods outlined above, connect the antenna to a network analyzer. Adjust the bandwidth of the network analyzer display such that the natural point of antenna resonance is visible in the display window. Have the display view broad enough so that if the antenna resonance is a few hundred MHz lower or higher, it will still be visible. The purpose is to know whether to tune the antenna up or down in frequency. If the natural resonance is lower than the wanted band, then the antenna is too long for this application and can easily be tuned to the center frequency by trimming the length. Take very small cuts on the length (for most of NXP designs, this means the top and bottom sides of the substrate) and re-measure the VSWR. Repeat this process until the antenna is centered in the band. If the natural resonance is higher than the wanted band, then the antenna is already shorter than needed for this band and a copper foil must be added carefully to the antenna length to move the resonant point down in frequency. If a foil must be added to increase the length, then add more than necessary so that the subsequent tuning can be done by cutting. After this is achieved, move to the impedance matching exercise.

4.3 Impedance matching components

Because many NXP's customers do not have the access to expensive equipment, NXP does not provide an elaborate method for matching using a simulator. Most of NXP's radios are tolerant to minor board changes that customers require. However, a customer board that is a copy of the NXP reference design may have a response that does not meet the performance parameters due to board parameter differences, application component interference, or encapsulation. In that case, the customer board must be re-tuned to optimize the RF performance. NXP does not maintain a reference library for matching purposes. Instead, NXP provides reference designs that are robust when copied carefully. Usually, the values of components that are chosen for NXP boards need very little adjustment for the customer boards. As the first step in re-tuning your application board, replace the series matching inductors with the next incremental values (up or down). Then measure and evaluate the TX power, Error Vector Magnitude (EVM), and RX sensitivity. There is usually a shunt capacitor or inductor placed across the differential outputs. Adjusting this value may be also necessary. Adjust the tuning values as necessary. Usually, the component values do not have to be modified by more than one increment (up or down).

5 Antennas

5.1 Quarter-wave monopole antennas

If one part of a half-wave dipole antenna is removed and replaced by an infinite ground plane, the remaining half of the dipole "mirrors" itself in the ground plane. This ground plane is sometimes called the counterpoise.

For all practical purposes, the monopole behaves as a "half-wave" dipole. That is, it has the same doughnut-shaped radiation pattern, the radiation resistance is a half of the half-wave dipole. It can be bent or folded like the dipole, and the same loading and feeding techniques can be applied. The feed point impedance of a dipole antenna is sensitive to its electrical length and feed point position. Therefore, a dipole performs optimally only over a rather narrow bandwidth. The real (resistive) and imaginary (reactive) components of that impedance are a function of electrical length. A quarter-wave monopole antenna has an impedance of $(73 + i43)/2 \Omega = 36 + i21 \Omega$.

A very important difference is that the antenna feed point is not balanced, but single-ended. Because of this, and because most RF circuits are of the unbalanced type, this antenna type is very popular and there are lots of variations of the monopole, mostly designed to match 50 Ω .

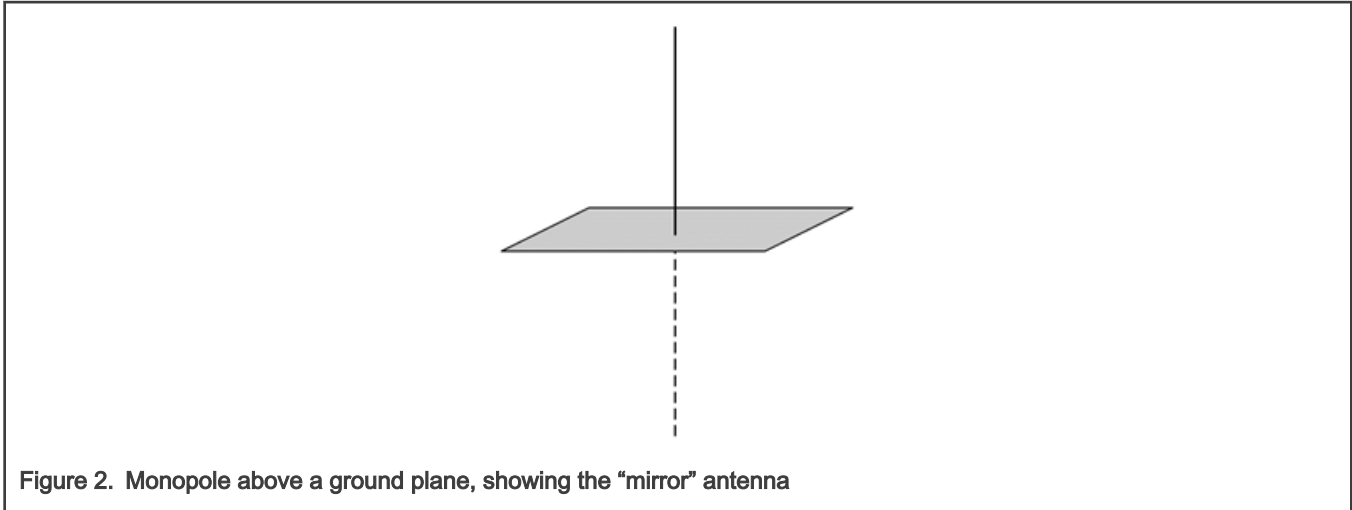

Note that the “whip” is only a half of the antenna and the remainder is made up of the ground plane (or counter weight). In a practical application, the ground plane is often made up of the remainder of the PCB (ground and supply planes, traces, and components) and/or the metal case of the device, if it has one.

The ground plane should be a reasonably-sized area when compared to the antenna and it should be as continuous as possible. If a monopole is used on a very small PCB, even with only a small area of copper, its efficiency suffers and the antenna is difficult to tune. Components and PCB tracks introduce additional losses and affect the feed point impedance.

For the dipole, resonance is typically obtained at a length slightly shorter than 1/4 of the wavelength. The radiation resistance is changed by bending the antenna. As with the dipole, the nulls in the theoretical radiation pattern can be reduced. By bending the antenna elements, the radiation resistance and efficiency drops, so the antenna should not be placed too close to ground. Like the dipole, the monopole can also be folded and bent around corners if the board space requires it. It can be loaded with series coils.

Of the many variations that exist, the following sections highlight the most common.

5.1.1 Open stub, tilted whip

If a monopole is bent and traced along the ground plane, it is more compact and the null in the radiation pattern is partly eliminated. The antenna should not be too close to ground, preferably not closer than 1/10 of the wavelength (1 cm), because it decreases efficiency. At this close spacing, the radiation resistance is so low (in the order of 10 Ω) that a matching network is needed. If the monopole is very close to ground, it acts as a transmission line instead of an antenna, with little or no radiation at all.

5.1.2 Inverted-F antenna

The F-antenna is similar to a tilted whip, where impedance matching is accomplished by tapping the antenna at the appropriate impedance point along its width. This antenna is used extensively, because it is reasonably compact, has a fairly omnidirectional radiation pattern, good efficiency, and it is very simple. Note that the currents in the ground leg are high and an adequate ground plane is necessary for good efficiency.

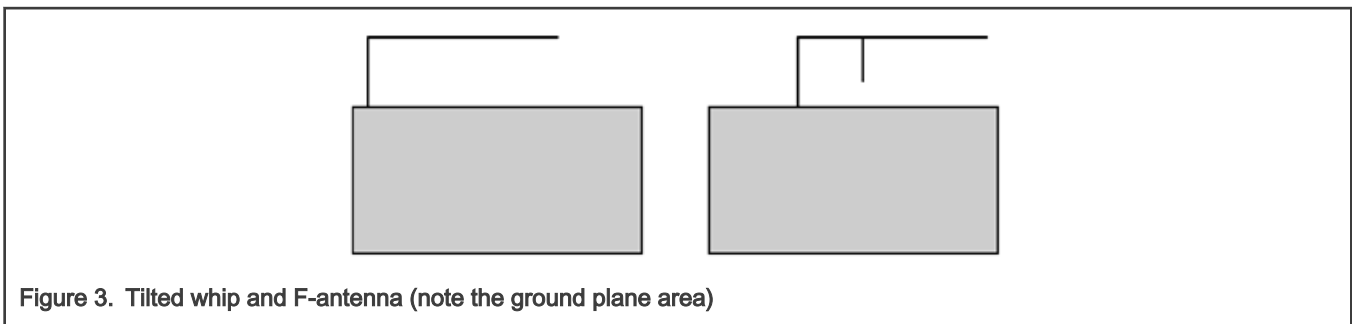

5.1.3 Meander antenna

The meander antenna or meander pattern is an antenna with the wire folded back and forth where resonance is found in a much more compact structure than can otherwise be obtained.

The meander, spiral, and helix antennas are similar in that their resonance is obtained in a compact space by compressing the wire in different ways. In all three cases, the radiation resistance, bandwidth, and efficiency drops off as the size decreases and tuning becomes increasingly critical. Impedance matching can be implemented by tapping (as with the F-antenna). The meander and helix antennas, or a combination of these two, are easily implemented in a PCB and many ceramic chip antennas are based on these antenna types.

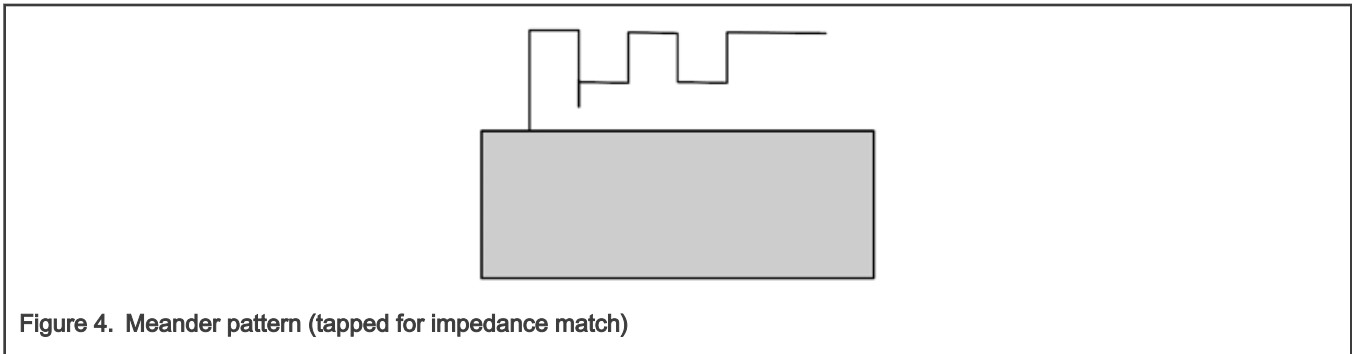

Figure 4. Meander pattern (tapped for impedance match)

5.2 Component antennas

5.2.1 Chip antennas

Numerous commercial chip antennas are available. Careful investigation reveals that most of these antennas are based on a helix, meander, or patch designs. To ensure proper operation, it is very important to follow the manufacturer's recommendations regarding footprint, ground areas, and mounting of the chip antenna. The "keep out" area around the antenna is especially important. Even following the recommendations does not always guarantee good performance due to de-tuning by nearby objects. It is expected that fine tuning of the antenna and/or a matching network is required to ensure satisfactory performance. Because chip antennas normally, but not always, use a ceramic material with higher dielectric constant and lower loss than the usual FR4, it is possible to build smaller antennas with reasonable efficiency.

Efficiency is not exceptionally high and it is typically in the range of 10-50 %, which corresponds to 3-10 dB loss (-3 to -10 dBi). The lower number are inferior products with high inherent losses. Buying a chip antenna does not guarantee good performance. While chip antennas provide the smallest antenna solution possible, the size reduction comes at a cost both in performance and pricing.

If a slightly larger PCB area than what is required by the chip antenna is available and the "keep out" area can be allocated to a PCB antenna, it is possible to implement a PCB antenna with the same (or better) performance than a chip antenna.

6 Miniaturization trade-offs

6.1 Antenna size

Reducing the antenna size results in reduced performance. Some of the parameters that suffer are:

- Reduced efficiency (or gain)
- Shorter range
- Smaller useful bandwidth
- More critical tuning
- Increased sensitivity to component and PCB spread
- Increased sensitivity to external factors

Several performance factors deteriorate with miniaturization, but some antenna types tolerate miniaturization better than others. How much a given antenna can be reduced in size depends on the actual requirements for range, bandwidth, and repeatability. An antenna can be reduced to a half of its natural size with moderate impact on performance. After a 1/2 reduction, performance becomes progressively worse as the radiation resistance drops off rapidly. Because loading and antenna losses often increase with reduced size, efficiency drops off quite rapidly.

The amount of loss that can be tolerated depends on the range requirements. Bandwidth also decreases, which causes additional mismatch losses at the band ends. The bandwidth can be increased by resistive loading, but this often introduces even more loss than the mismatch loss. The low bandwidth combined with heavy loading requires a spread analysis to ensure adequate performance with variations in component values and PCB parameters. It is often better not to reduce antenna size too much, if the board space allows it. Even if the range requirements do not require optimum antenna performance, production problems and spread are minimized. It is also best to keep some clearance between the antenna and nearby objects. Although the antenna may be retuned to compensate for the loading introduced by the surrounding objects, tuning becomes more critical and the radiation pattern can be heavily distorted.

6.2 Baluns

Many antennas mentioned in this document are single-ended and designed to have feed point impedance close to 50 Ω . A balun is required to interface these antennas to a balanced output/input. The balun converts a single-ended input to a balanced output together with optional impedance transformation. The output is differential. That is, the output voltage on each pin is of equal magnitude, but of opposite phase. The output impedance is normally stated as the differential impedance measured between the two output pins. The balun is bidirectional. The balanced port can be both input or output.

There are several discrete circuits that perform as baluns, but most of them are sensitive to input and output loading and PCB layout issues, which requires cumbersome fine tuning. Also, all of these require at least two chip inductors. In the 2.4 GHz band, there are small ceramic baluns that are easy to use and less sensitive to the PCB layout with standard output impedances of 50, 100, and 200 Ω .

The cost of a discrete balun is comparable to that of a ceramic balun and a ceramic balun requires less board space. The ceramic balun is recommended for most designs.

7 Potential issues

Numerous things can go wrong with an antenna design. The following list provides a few do's and don't's that may serve as a good checklist for a final design. Many of these items seem obvious to experienced antenna designers, but many of these issues are routinely encountered in practice. This is not a complete list:

- Never place ground plane or tracks underneath the antenna .
- Never place the antenna too close to metallic objects .
- In the final product, ensure that the wiring and components do not get too close to the antenna .
- A monopole antenna needs a reasonable ground plane area to be efficient .
- Perform the final tuning in the end - product enclosure, not in open air .
- Never install a chip antenna in a vastly different layout than the reference design and expect it to work without tuning .
- Do not use a metallic enclosure or metallized plastic for the antenna .
- Test the plastic casing for high RF losses, preferably before production .
- Never use low-Q loading components or change the manufacturer without retesting .
- Do not use too narrow PCB tracks. The tracks should be relatively wide (as the space allows) .

8 Recommended antenna designs

The recommendation for antenna design employed by NXP for the BLE or IEEE 802.15.4 protocol compliant hardware includes two substrate antenna designs and a chip component design:

1. Inverted-F antenna for best range performance
2. Meander antenna for reduced size
3. Chip antenna for rapid time-to-market

All recommended antenna designs have a 50-Ohm single-ended interface. The inverted-F antenna has its limitations where board space is critical. If range is not an issue, the trade-off of space for range can be employed by a meandering inverted-F antenna. The inverted-F and the meandering inverted-F antennas are directional antennas and the orientation of the antenna on the board affects the range. This is usually not a big concern for well-tuned radios that must operate only within a relatively small space, such as a living room, where the radio is employed as a remote control.

While the inverted-F and meandering inverted-F antennas represent the lowest cost options for antennas, they are not necessarily the best choice for time-to-market due to the need to tune them. If the time frame to move the end product into the market place is paramount, employing the chip antenna for early production can generate revenue while a less expensive board level inverted-F antenna can be developed and implemented as a cost reduction measure.

9 Design examples (antennas on the NXP EVK boards)

The following section shows a series of design examples. Each of these is tuned for a particular design, so a cut-and-paste approach does not necessarily ensure optimum performance. However, these designs are a good starting point for further optimization, and they indicate the approximate size of the antenna.

9.1 Inverted-F Antenna (IFA)

The NXP FRDM evaluation kits are designed for use in the nodes of low-power wireless networks based on the BLE or IEEE 802.15.4 protocol standards. These networks may employ higher-level networking protocols built on top of the BLE or IEEE 802.15.4 layers. The antenna for use with a FRDM board device must be selected by the developer and this chapter provides radiated graphs for a suitable high-performance IFA. The FRDM board has an advantage to use the RF SMA connector also for other available monopole antennas or this RF path can be used for planar IFA measurement.

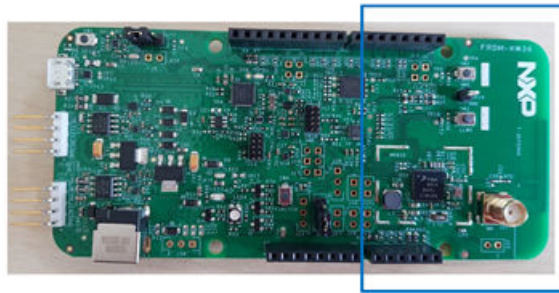

Figure 5. FRDM-KW36 evaluation board



Figure 6. RF part including IFA antenna

9.1.1 IFA dimensions

Figure 7 shows the inverted F antenna dimensions for the FRDM board usage. All dimensions are in millimeters.

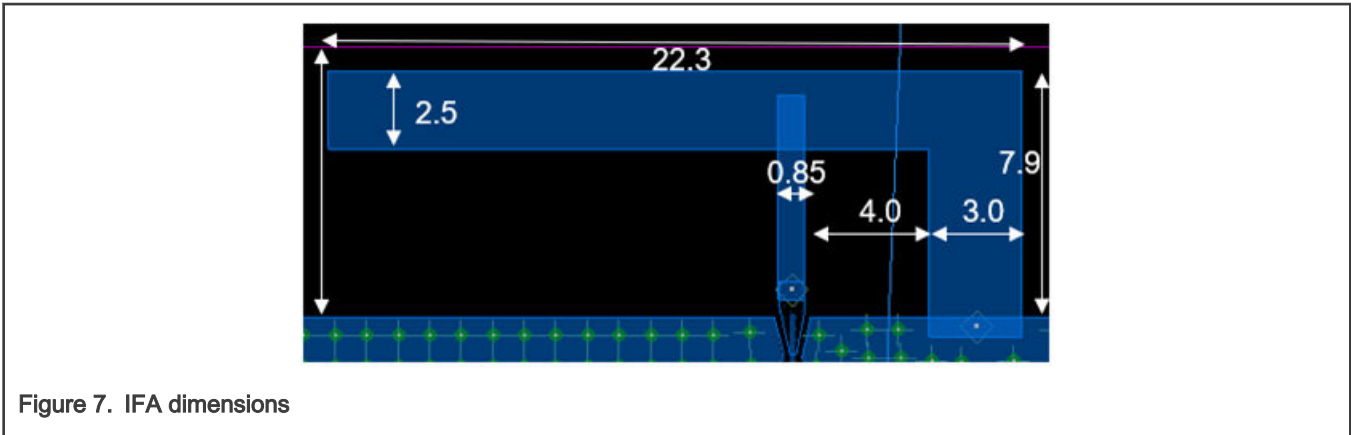
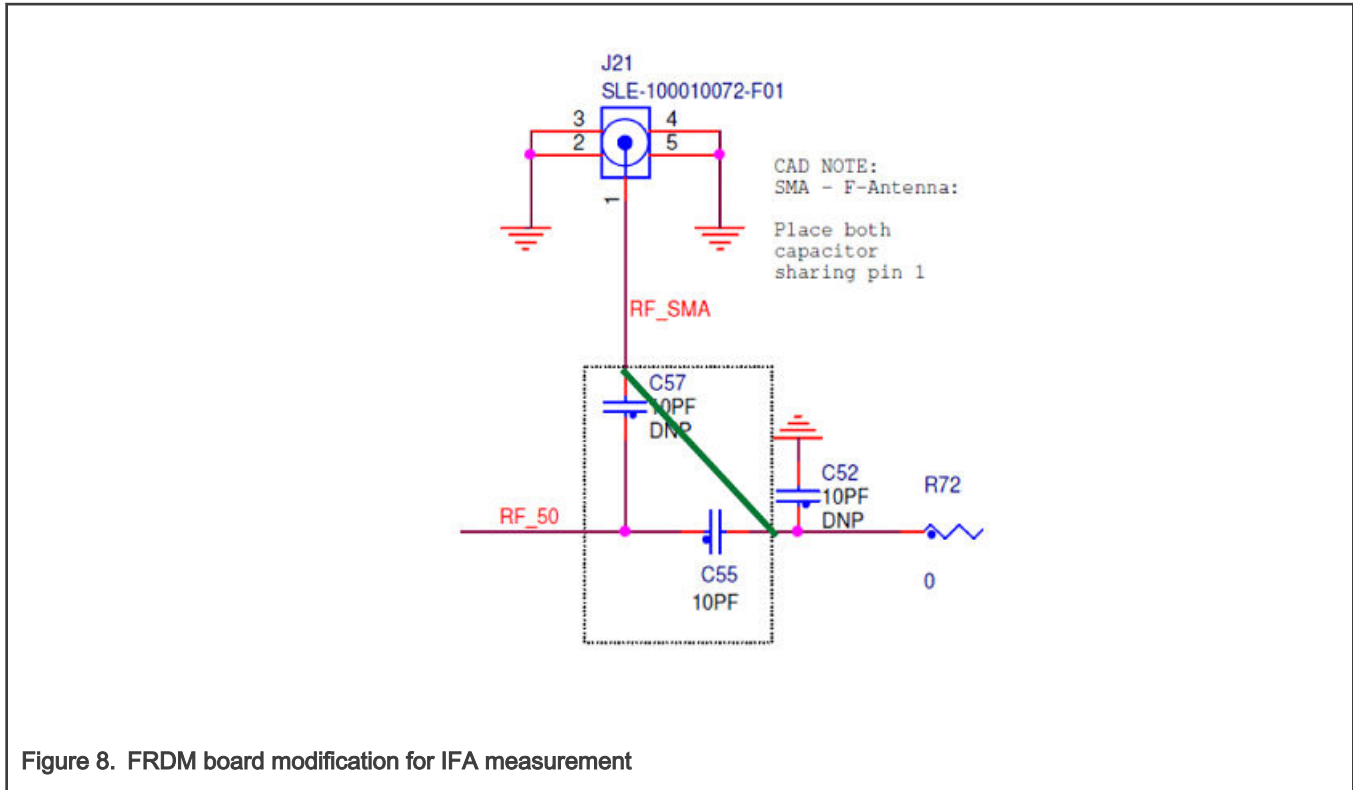

Figure 7. IFA dimensions

9.1.2 Reflection coefficient measurement

The measurement of the S parameters (S11) is performed by disconnecting the C55 and C57 capacitors and making a connection marked by the green line only (the IFA is directly wired to the SMA connector).



The result of the reflection coefficient S11 is displayed in the graph below. The following two markers show the values:

S11 [2.4 GHz] = -10.49 dB

S11 [2.48 GHz] = -14.68 dB

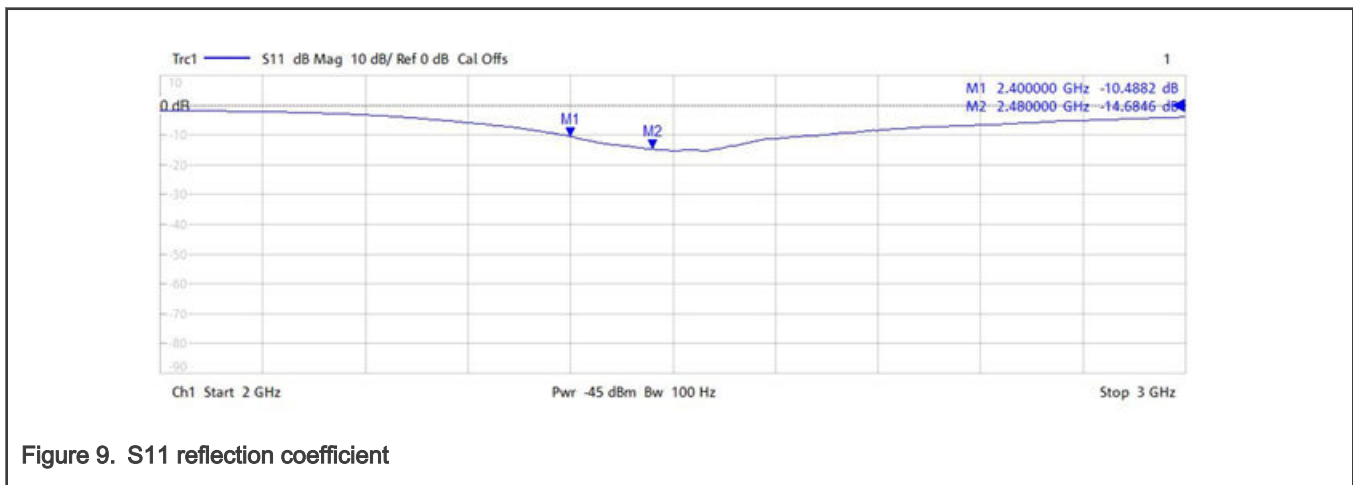
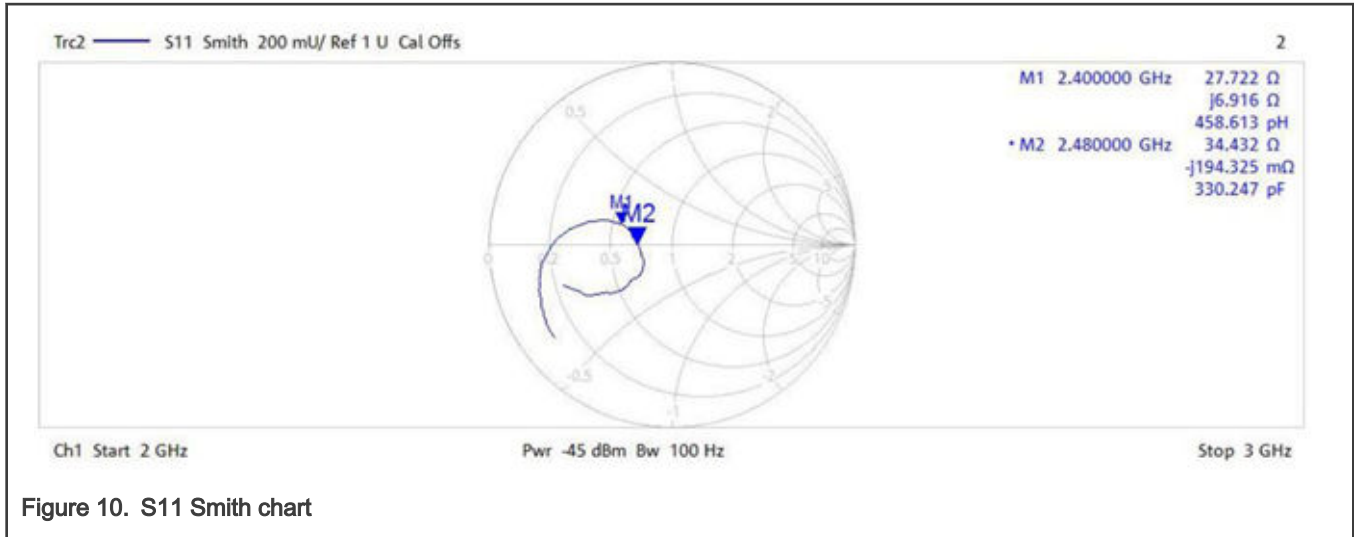
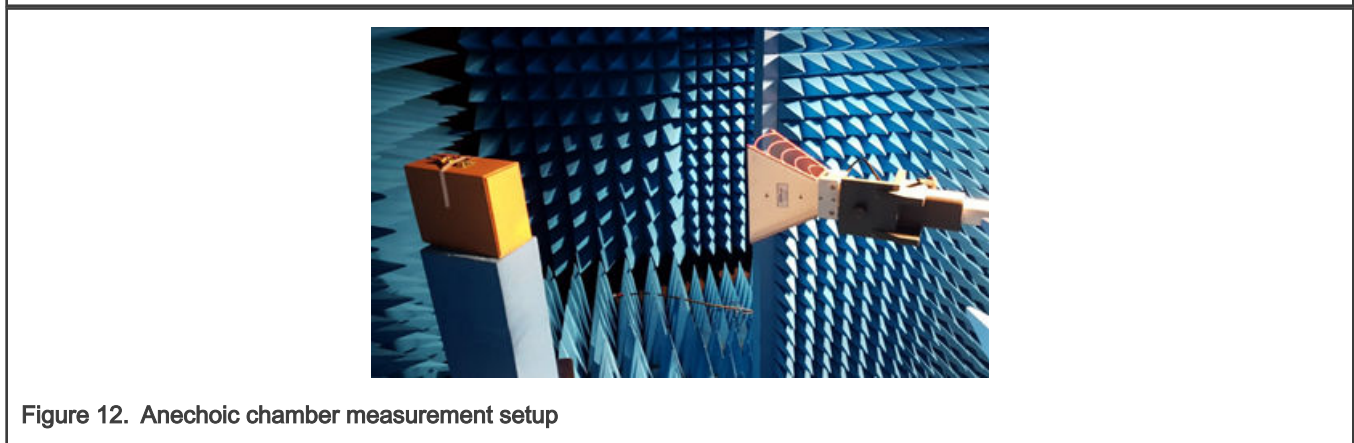
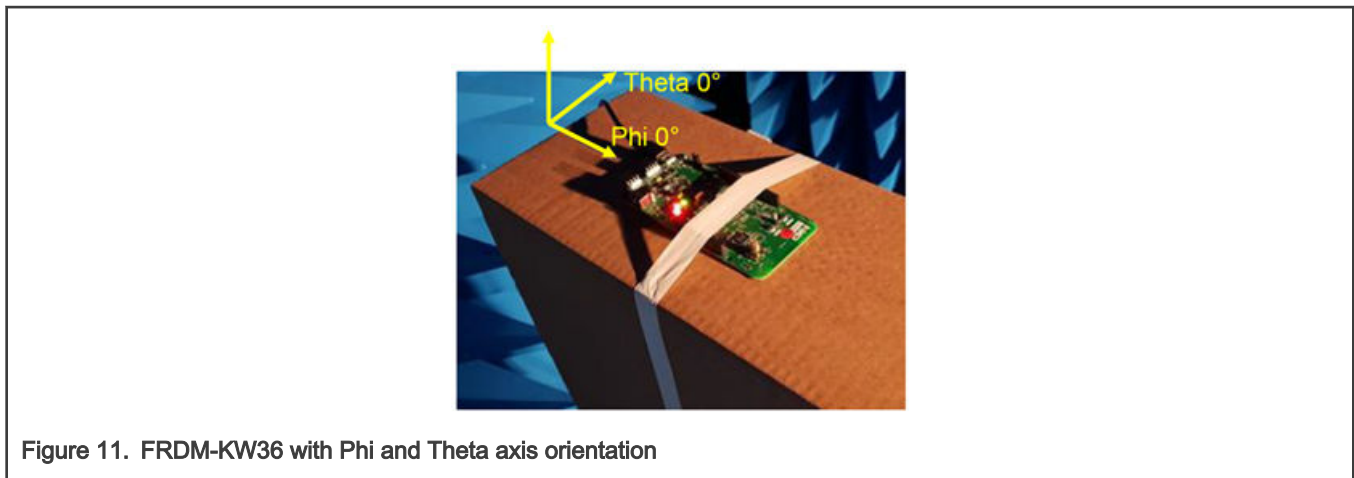

Figure 10 shows the measured values of the S11 reflection coefficient, including the IFA impedance.



9.1.3 IFA radiation pattern

The radiation pattern measurement was performed inside an anechoic chamber. Figure 11 and Figure 12 show the horizontal FRDM board orientation.



The reference/measurement antenna was oriented in vertical and horizontal positions. Figure 13 and Figure 14 show the antenna radiation pattern shape for the horizontal and vertical IFA reception. The FRDM board was rotated by varying the ϕ angle. The

maximum gain for the horizontal orientation was reached at the angle of 155 degrees with a value of 0 dBi. The referenced antenna vertical orientation shows the maximum gain at an angle of 145 degrees with a value 0 dBi as well.

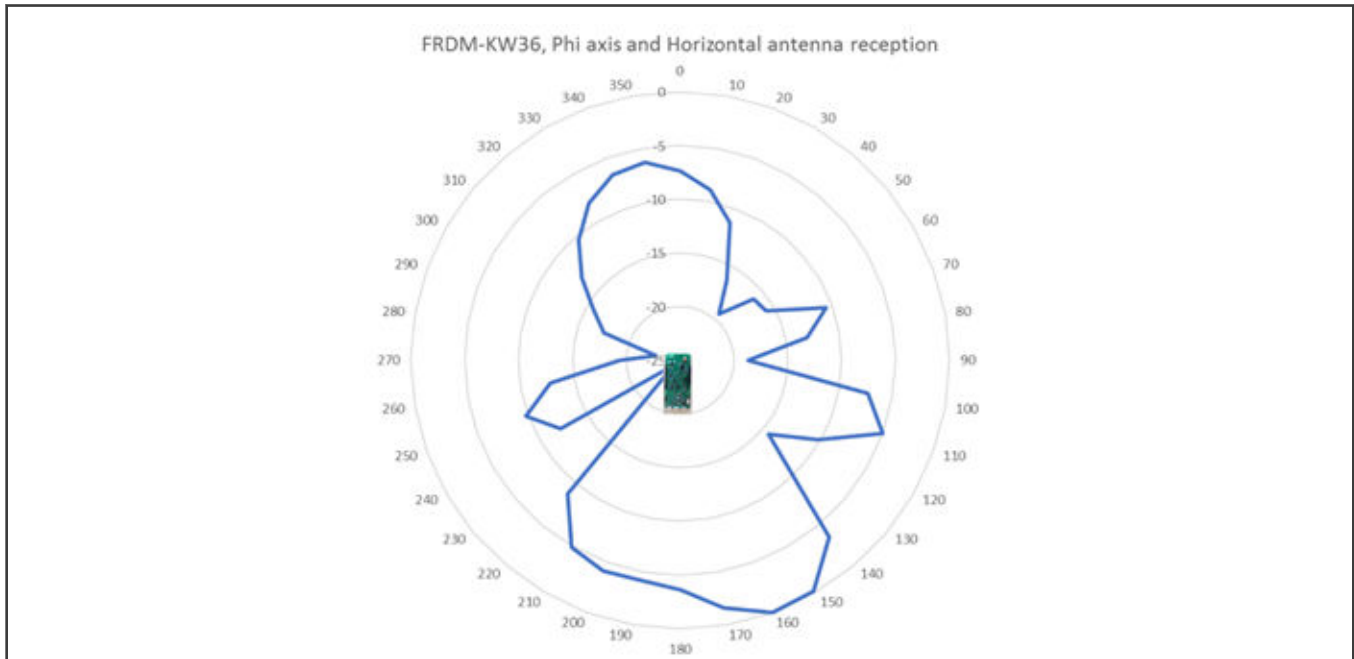

Figure 13. IFA antenna – gain and directivity diagram in Phi axis, maximum gain at 155°

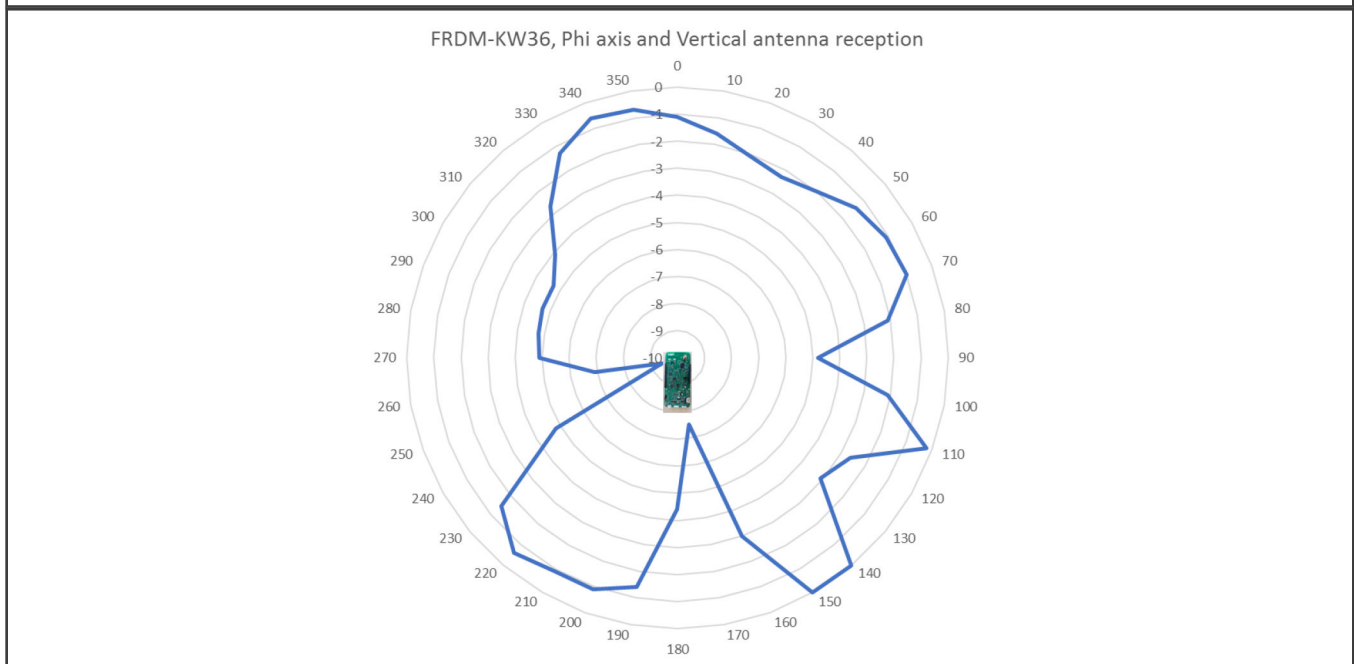

Figure 14. IFA antenna – gain and directivity diagram in Phi axis, maximal gain at 145°

The vertical FRDM board position is shown in [Figure 15](#). This position enables you to measure the IFA antenna among the θ plane.

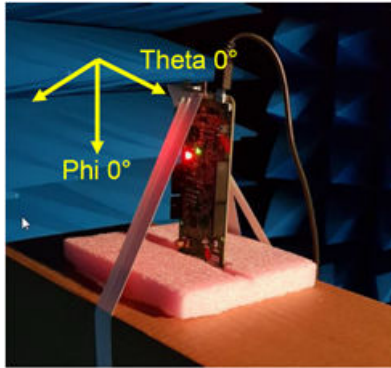

Figure 15. FRDM-KW36 with Phi and Theta axis orientation

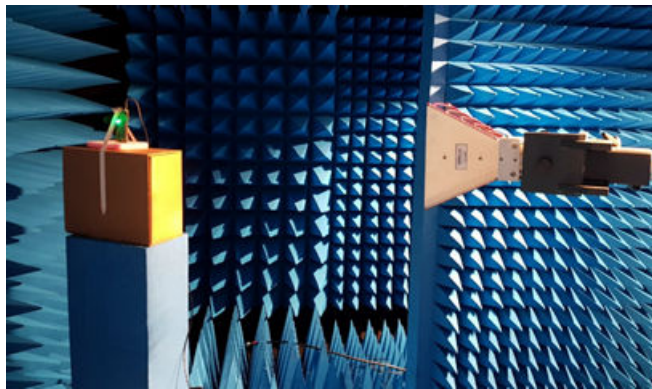

Figure 16. Anechoic chamber measurement setup

Figure 17 and Figure 18 show the antenna radiation pattern shape for the horizontal and vertical IFA reception along the θ angle. The FRDM board was rotated and the maximum gain for the horizontal antenna reception was reached at the angle of 0 degrees with a value close to 0 dBi. The referenced antenna vertical orientation shows the maximum gain at an angle of 110 and 260 degrees with a value of up to 0 dBi.

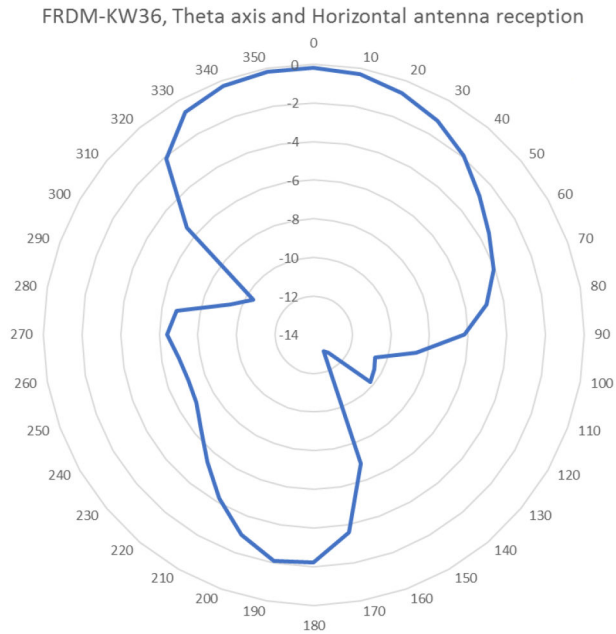

Figure 17. IFA antenna – gain and directivity diagram in Theta axis, maximum gain at 0°

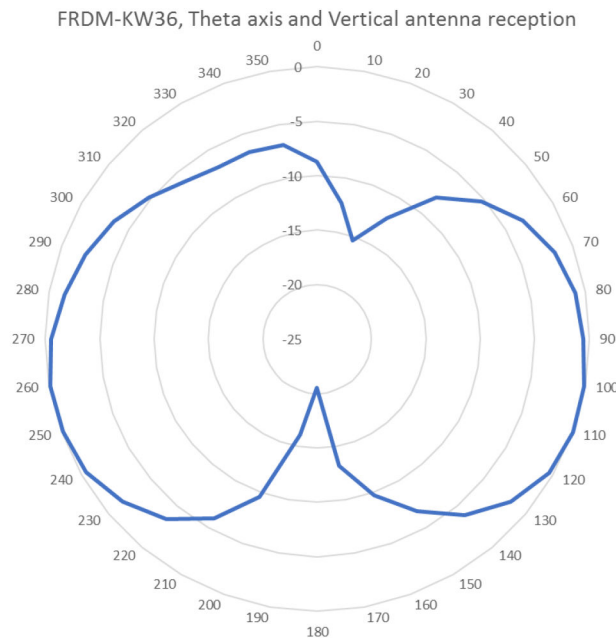

Figure 18. IFA antenna – gain and directivity diagram in Theta axis, maximum gain at 110° and 260°

9.2 Meandered Planar Inverted-F Antenna (PIFA)

This section describes the meandered Planar Inverted F Antenna (PIFA) implementations on the NXP boards. This type of antenna is widely used on USB dongles or extended-range modules. The whole RF part is usually more compact convenient for smaller designs. The antenna consists of a monopole antenna in parallel to a ground plane and grounded at one end. The antenna is fed from an intermediate point and distance from the grounded end. The ground plane size of the PCB itself and the substrate material have a significant influence on the antenna parameters. This is the reason why the PCB antenna should be slightly tuned for different board (ground plane) size.

9.2.1 Meander antenna dimensions

Figures below show the dimensions of the meandered PIFA for two different PCB designs. The USB dongle board and extended-range board are equipped with the same meander antenna. However, each antenna is slightly modified with respect to all important PCB parameters.

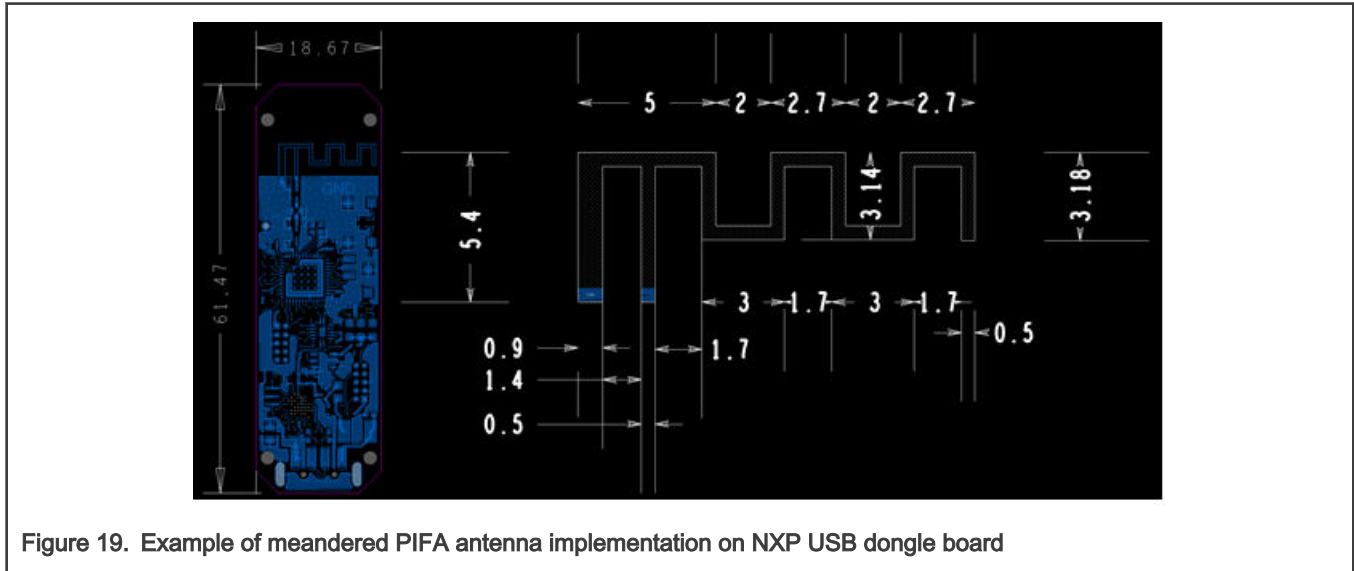

Figure 19. Example of meandered PIFA antenna implementation on NXP USB dongle board

The difference is in the meander antenna length (represented by the length of the last antenna finger) and the grounded end of the F antenna. The distance between the feeding point and the grounded end antenna has direct influence on the antenna input impedance.

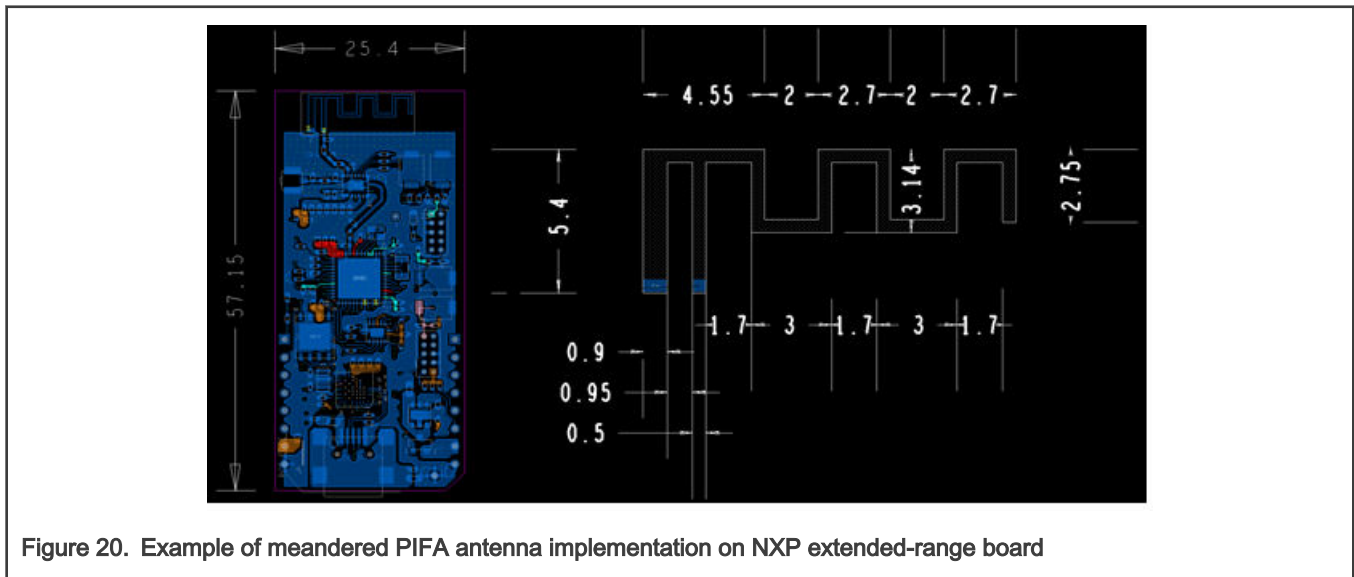

Figure 20. Example of meandered PIFA antenna implementation on NXP extended-range board

The same substrate material and thickness is used for both boards. The board stackup is shown in [Figure 21](#). One of the important factors is the quality of the substrate material. The commonly-used FR4 substrate has a wide spread of the relative permittivity in the range of 4.3 – 4.5. The frequency shift of the central tuned antenna frequency may vary.

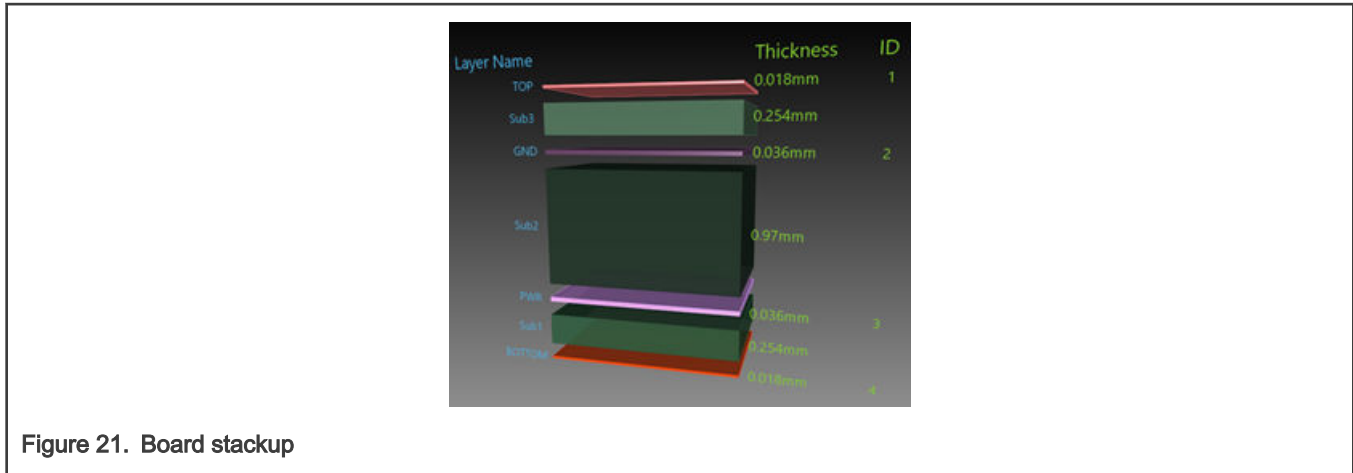

Figure 21. Board stackup

9.2.2 Simplified model description and simulation results

Simplified PCB models were created using the Ansys Electronics Desktop tool. The models correspond to the USB dongle and extended-range boards' physical parameters. 3D radiation patterns with the mentioned boards are shown below with the corresponding XYZ axes and Theta (θ)/Phi (ϕ) planes.

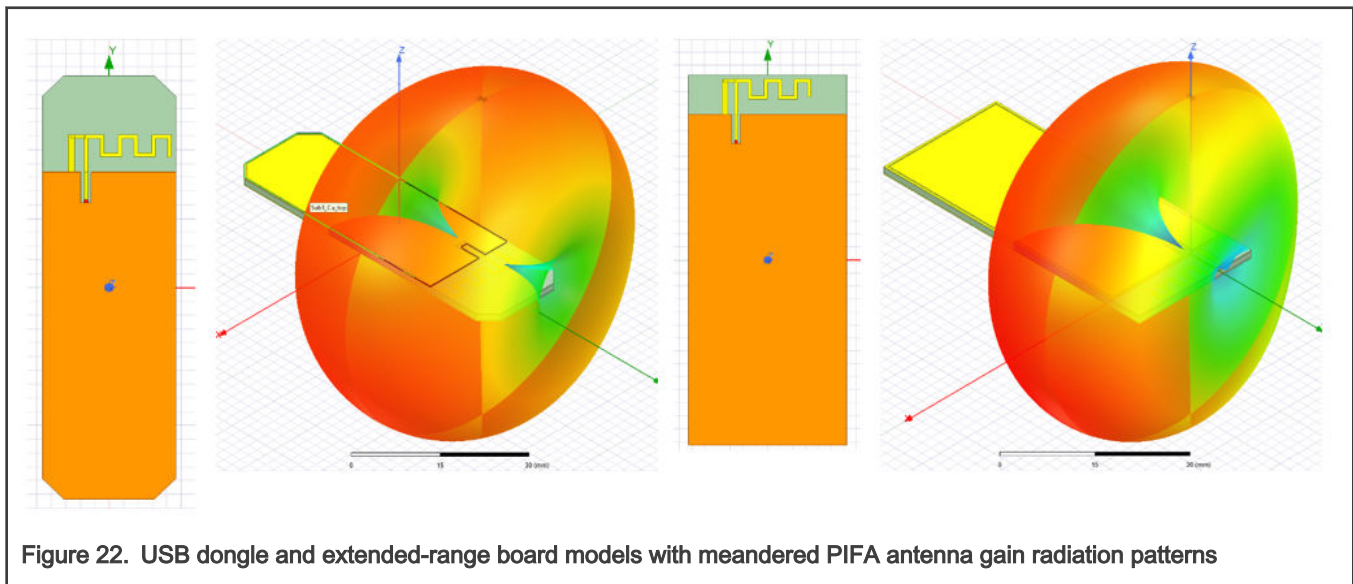

Figure 22. USB dongle and extended-range board models with meandered PIFA antenna gain radiation patterns

The positive X axis usually follows the zero ϕ angle. The shape of the pattern may slightly vary with different ground plane size, as shown in the figures. The meandered PIFA antenna performance is slightly affected and it must be individually evaluated for both boards.

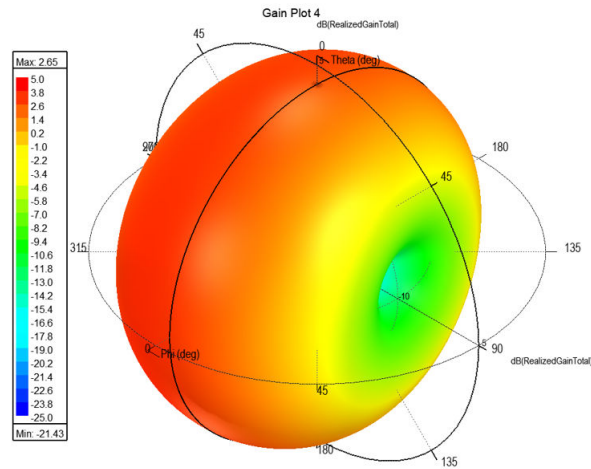

Figure 23. 3D gain radiation pattern of USB dongle board including angle axis

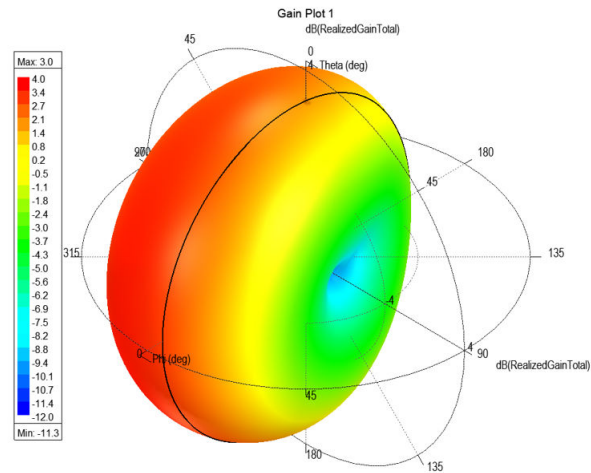

Figure 24. 3D gain radiation pattern of extended-range board including angle axis

The 2D polar plot shows two important cross-sections. This is shown in [Figure 25](#) and [Figure 26](#). The red curve represents horizontal polarization and corresponds to the cross-section at 0 degrees of the ϕ angle. The θ angle varies in the range of ± 180 degrees. The green curve shows vertical polarization and corresponds to the cross-section on 90 degrees of the ϕ angle.

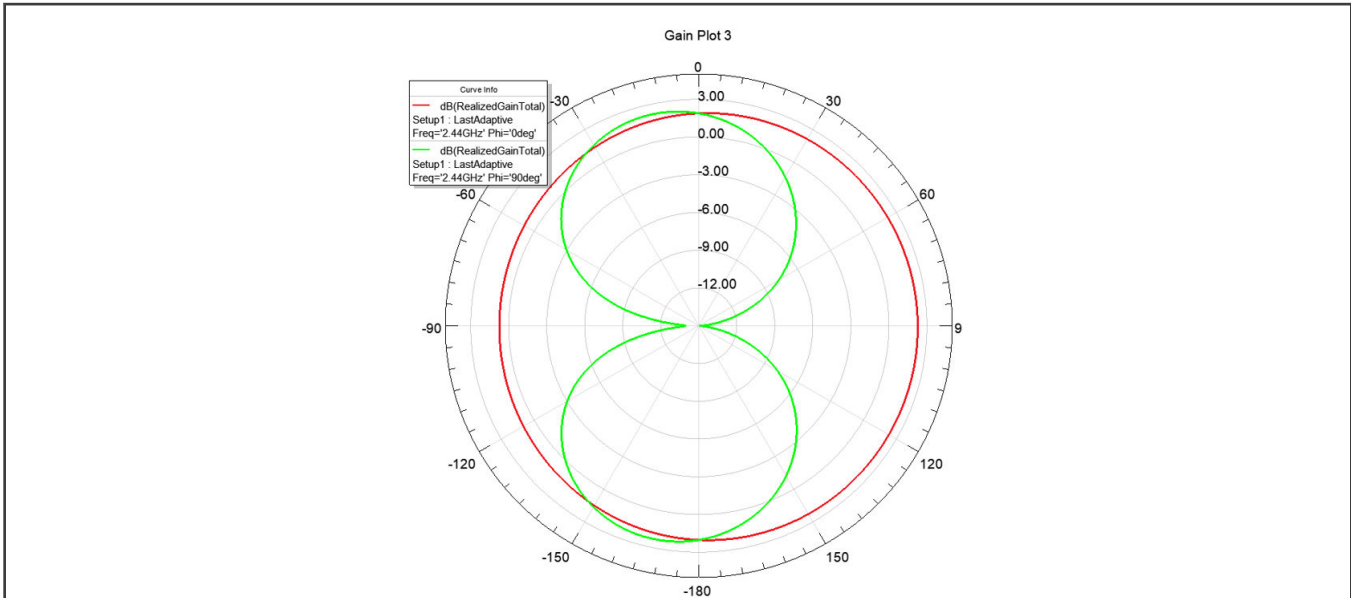

Figure 25. USB dongle meandered PIFA antenna radiation pattern, red curve – horizontal polarization, green curve – vertical polarization

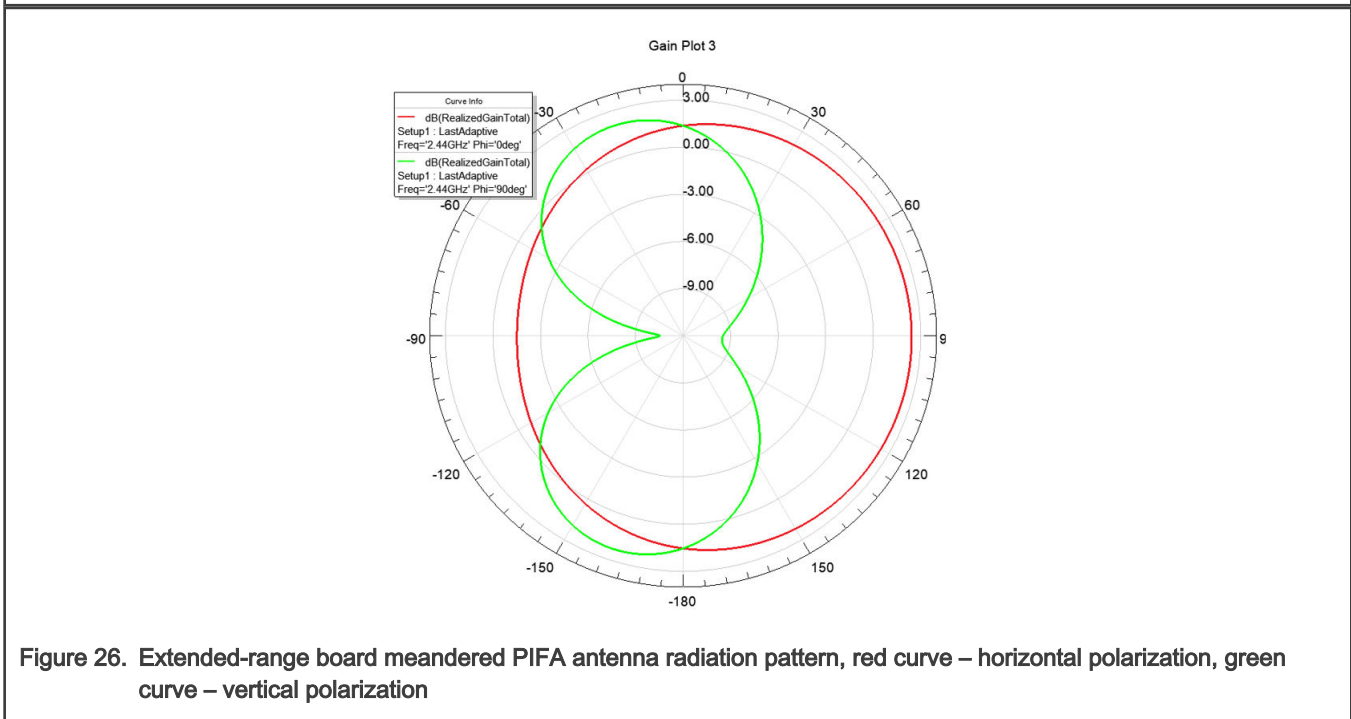

Figure 26. Extended-range board meandered PIFA antenna radiation pattern, red curve – horizontal polarization, green curve – vertical polarization

Figure 26 shows more asymmetric radiation pattern behavior of the meandered PIFA antenna on the extended-range board.

9.2.3 USB dongle PIFA antenna results of reflection coefficient

The reflection coefficient (return loss) S11 is usually evaluated or measured. Figure 27 shows the variations of the reflection coefficient for the different relative permittivity of the FR-4 substrate material. The Smith chart is also shown. The curve should be as close as possible to value 1. The reason to show a variation of the relative permittivity comes from unstable parameters of the FR-4 substrate material from different manufactures.

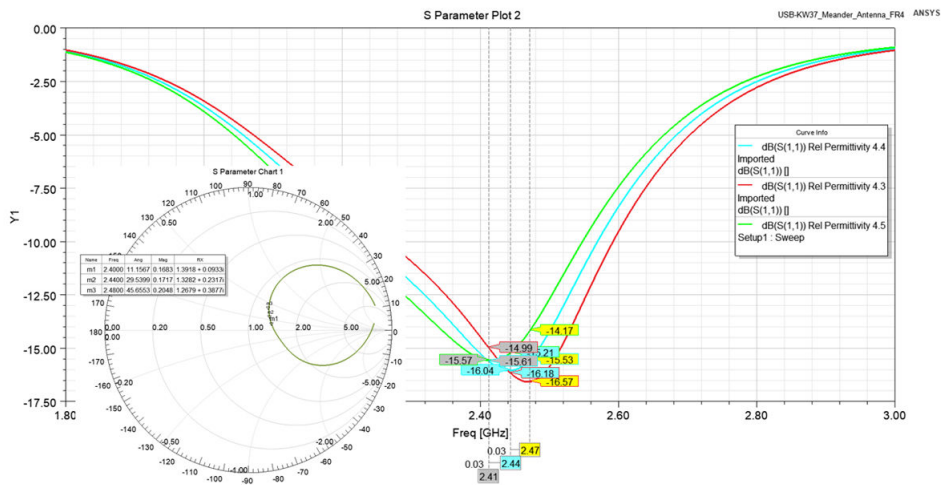

Figure 27. USB dongle meander antenna – reflection coefficient S11 with Smith chart, S11 varies with relative permittivity

The lowest tuned value of the reflection coefficient can be shifted by ± 35 MHz with a variation of the relative permittivity of 0.1.

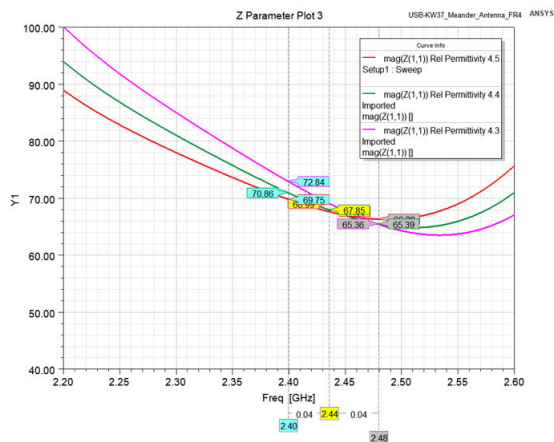

Figure 28. USB dongle – meandered PIFA antenna input impedance

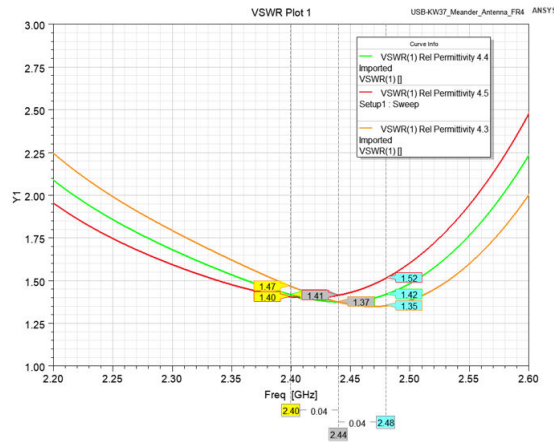

Figure 29. USB dongle – meandered PIFA antenna VSWR

The current PIFA antenna design shows some immunity to the relative permittivity variation, because of the antenna useful frequency band (S11 values below -10 dB) equals 300 MHz.

The other parameters derived from the S11 reflection coefficients are the antenna input impedance and the VSWR. Those characteristics are shown in Figure 28 and Figure 29. The input antenna impedance should be as close as possible to 50 Ω. The VSWR shows the quality of antenna matching. The values below number 2 characterize good antenna matching.

9.2.4 Extended-range PIFA antenna results of reflection coefficient

The extended-range meandered PIFA antenna results show a very similar behavior. The reflection coefficient S11 is shown Figure 30 in with the relative permittivity variation of the FR-4 substrate material. The Smith diagram is also attached. It seems the lowest tuned value of the reflection coefficient can be shifted by approximately ± 20 MHz with variation 0.1 of the relative permittivity.

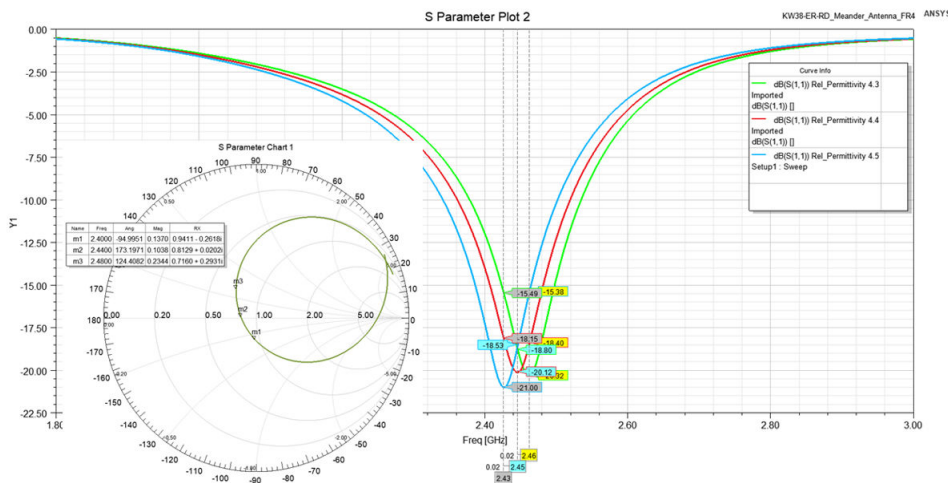

Figure 30. Extended-range board – meandered PIFA antenna reflection coefficient S11 with Smith chart, S11 varies with relative permittivity

The meandered PIFA antenna is more selective in this case. The immunity to the relative permittivity variation and corresponding frequency shift is approximately 200 MHz due to the antenna useful frequency band. Other derived parameters from the S11 reflection coefficients are displayed in Figure 31 and Figure 32. The input antenna impedance reaches the values close to 50 Ω. The VSWR values also reach number 1 (ideal frequency matching).

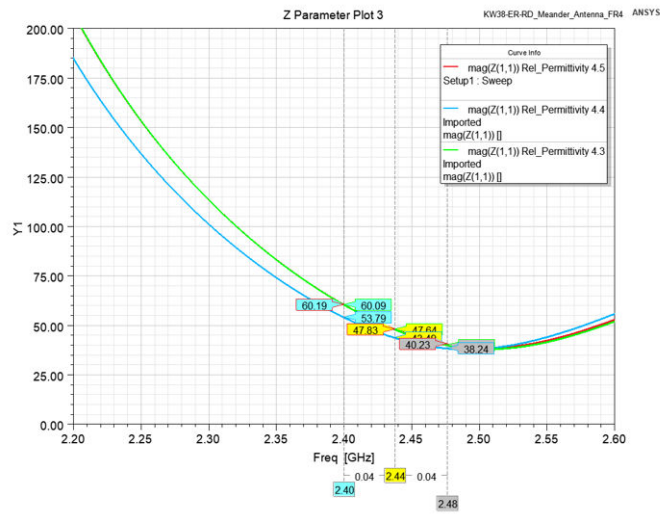

Figure 31. Extended-range board – meander antenna impedance

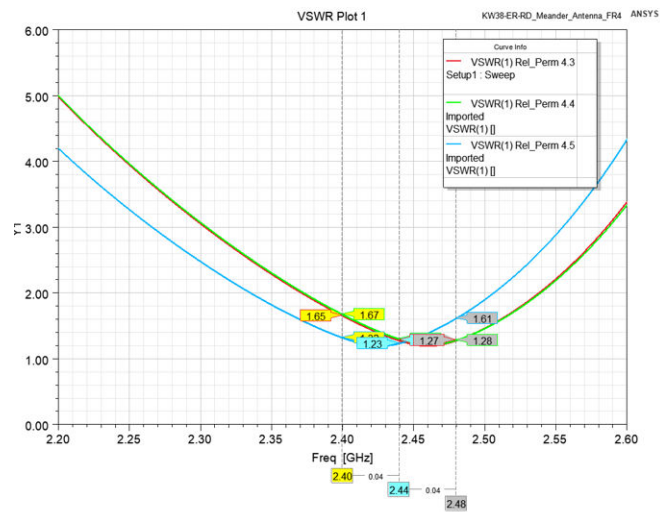

Figure 32. Extended-range board – meander antenna VSWR

9.3 Circular patch antenna

A circular patch is a type of antenna with a low profile, which can be also mounted on a flat surface like the other planar antennas. It consists of a flat circular electric conductor mounted over a larger conducted ground plane. The shape of the patch might be different (rectangle, square, star, and so on). The current example uses a circular shape. Multiple patch antennas on the same substrate can be used to make an antenna array. A circular patch antenna is usually larger than a meandered planar inverted-F antenna or an inverted-F antenna.

9.3.1 Circular patch antenna example

The following example shows the circular patch antenna placed on a 3-layer PCB. The patch diameter is 34.1 mm and the rectangular board size is 80x80 mm. The figure below shows a simplified model. It was created using the Ansys Electronics Desktop tool.

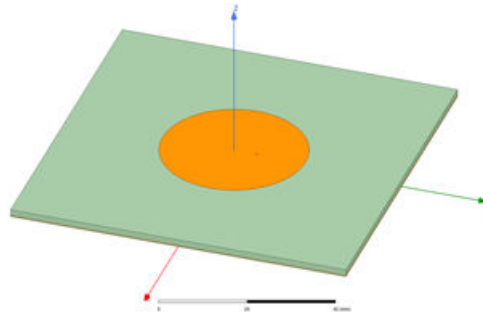

Figure 33. Circular patch antenna model with PCB example

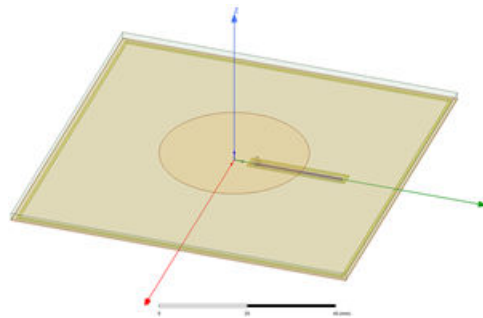

Figure 34. Circular patch antenna model with coaxial probe and feeding line on the bottom

The circular patch uses a coaxial probe for feeding. This is shown in [Figure 34](#) together with a coplanar waveguide working as a feeding line on the bottom side. The coaxial probe is placed 5.5 mm from the circular patch center.

Layer Name	Thickness	ID
Top	0.018mm	1
Sub_2	1.6mm	
GND	0.036mm	2
Sub_1	0.3mm	
Bottom	0.018mm	3

Figure 35. Circular patch antenna PCB board stackup

The substrate material and thickness correspond to the board stackup in [Figure 35](#). The example uses the asymmetric layers design. The distance between the Top and GND layers is 1.6 mm and the distance between the GND and Bottom layers is 0.3 mm. The middle ground plane layer works as a mirror for the circular patch and it provides good grounding for the coplanar waveguide. The antenna was tuned to meet the current conditions. The commonly used FR4 material was chosen as the substrate with relative permittivity in the range of 4.3 – 4.5.

9.3.2 Circular patch antenna reflection coefficient simulation results

This chapter shows the circular patch antenna simulated results of the reflection coefficient together with impedance and VSWR. [Figure 36](#) shows the circular patch antenna reflection coefficient. It shows the antenna resonant frequency at 2.44 GHz. The minimum value reaches -25 dB.

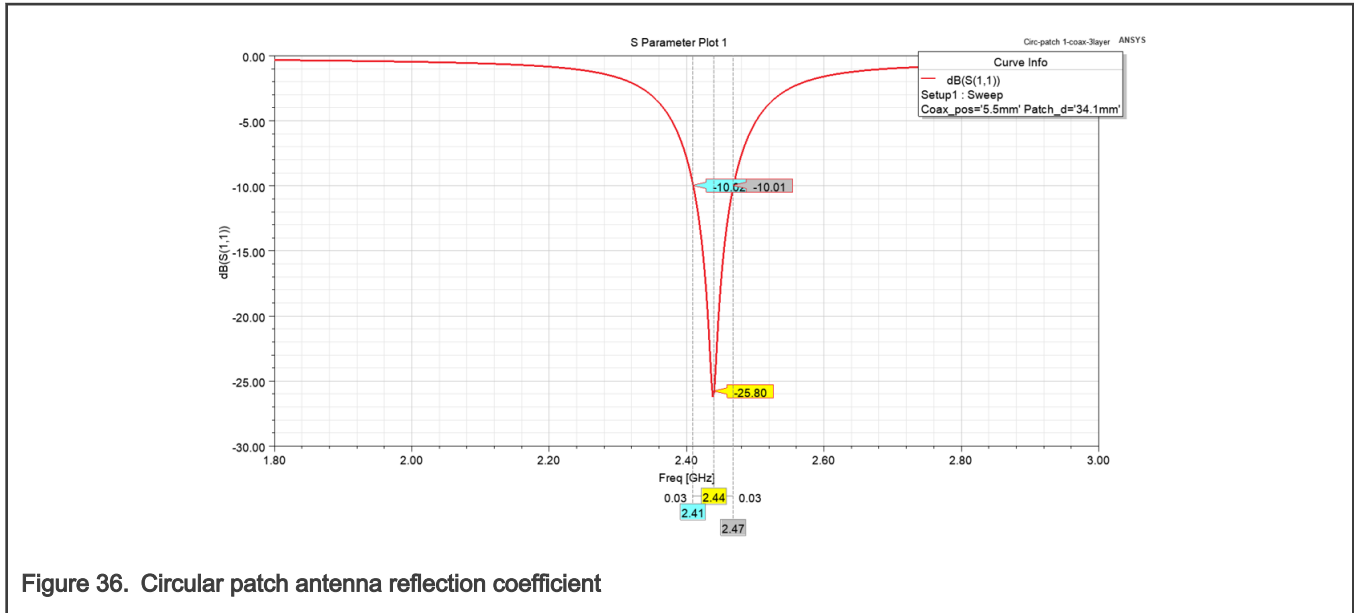

The frequency bandwidth of the circular patch is slightly narrower in comparison with other antennas. The current situation shows approximately 60-MHz bandwidth (marked in the figure). The Smith chart corresponding to that situation is in [Figure 37](#). The resonant frequency is close to the middle point 1 of the Smith diagram.

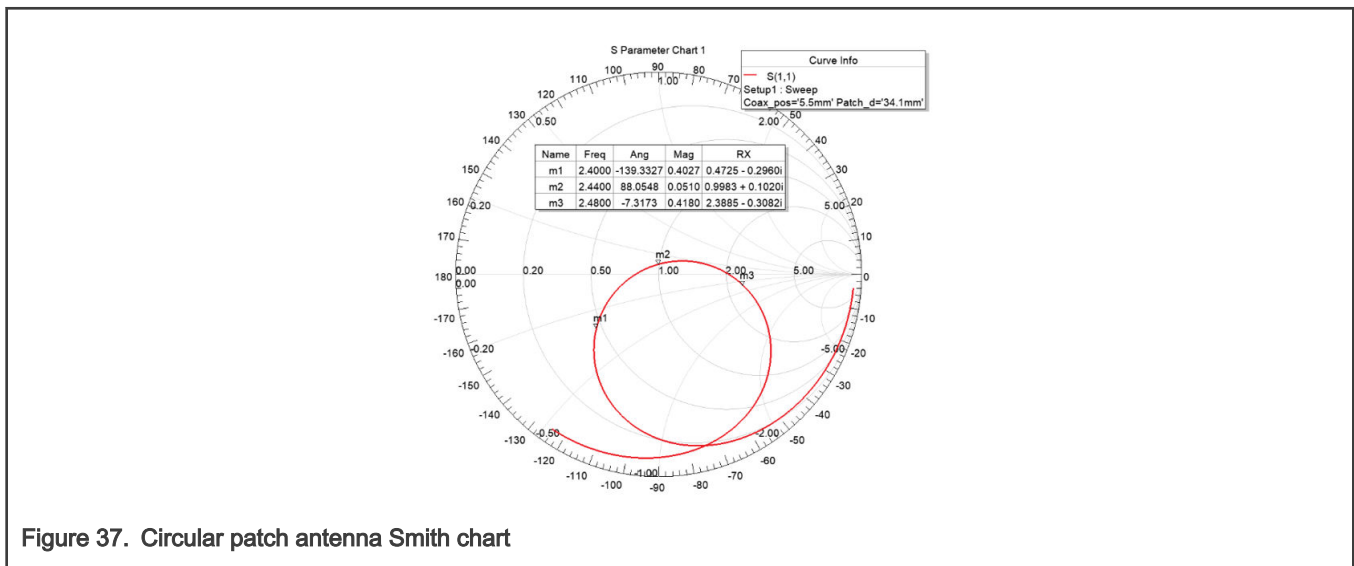

The circular patch antenna impedance and the VSWR chart are in [Figure 38](#) and [Figure 39](#). The antenna impedance varies in the wider range. The antenna is ideally matched at the frequency of 2.4 GHz.

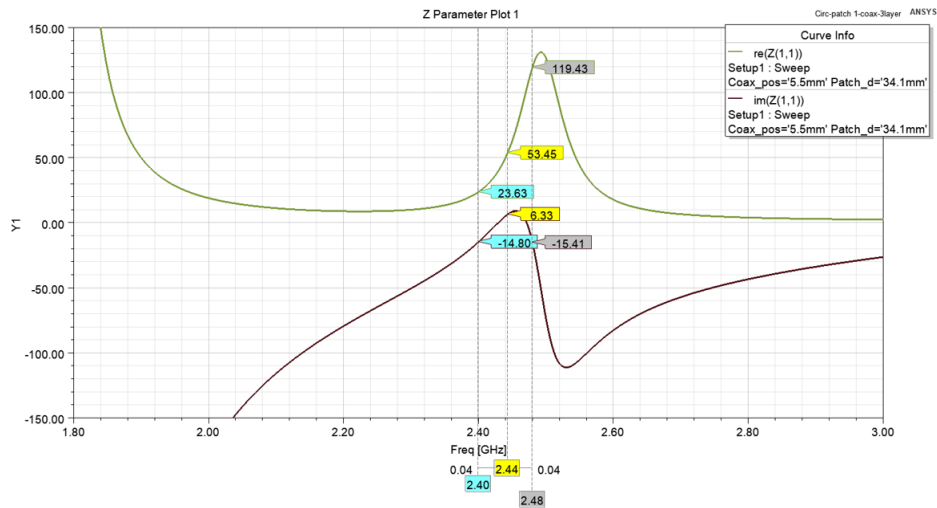

Figure 38. Circular patch antenna – impedance

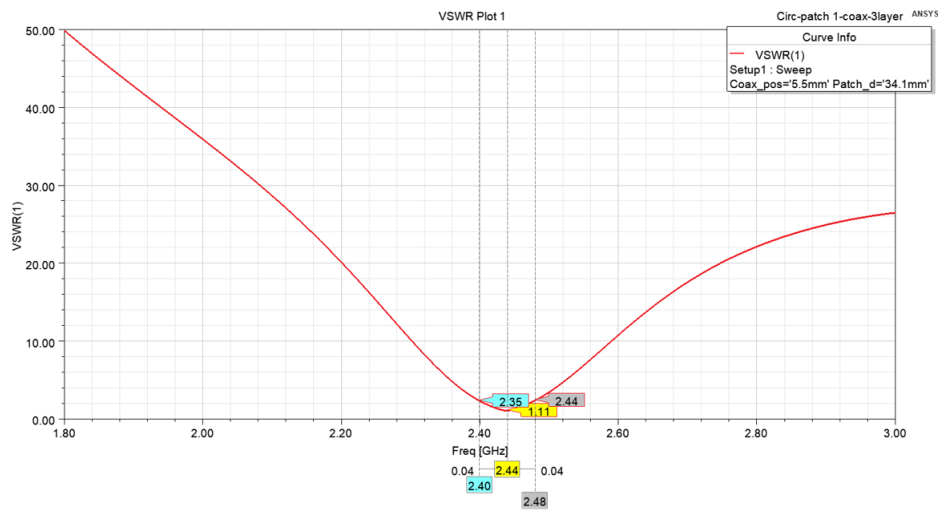

Figure 39. Circular patch antenna – VSWR

9.3.3 Circular patch antenna radiation pattern simulation results

Following figures display the 3D radiation pattern of the circular patch antenna with the PCB. The maximum intensity is represented by the red color and the gain reaches 3.4 dBi.

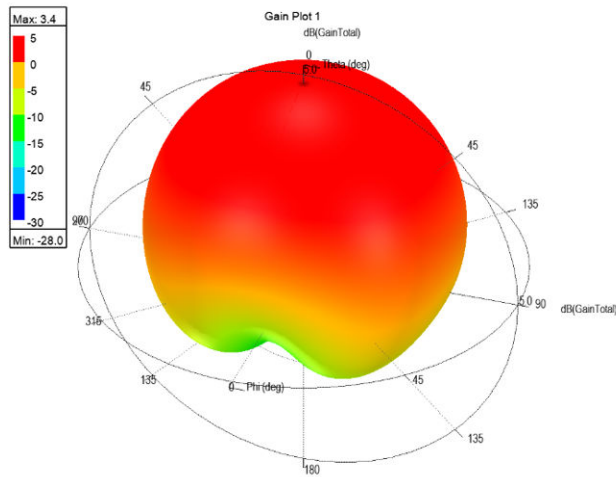

Figure 40. 3D gain radiation pattern of circular patch antenna

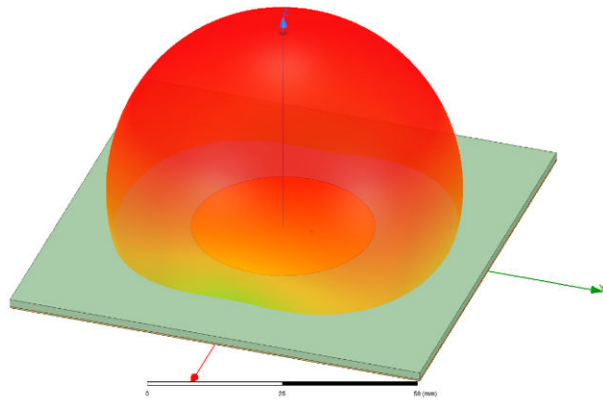
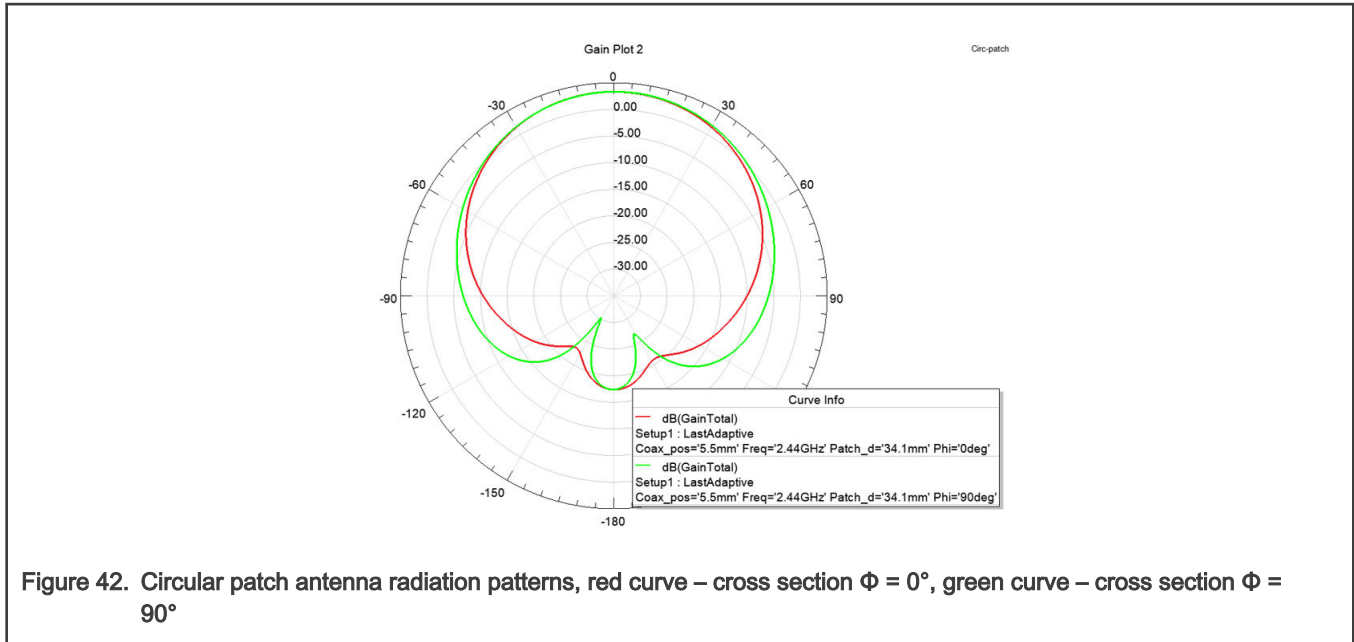

Figure 41. 3D gain radiation pattern of circular patch antenna with PCB

Figure 42 shows a polar graph with 2D radiation pattern using the most important cross-sections (in the ϕ axis).



9.4 Chip antenna

There are many chip antenna designs and NXP strongly recommends carefully following the antenna manufacturer guidance regarding ground, keep-out areas, and so on.

The chip antennas often have a resonant frequency above/below 2.44 GHz and the return loss at 2.44 GHz might be poor with no tuning/matching components. The antenna must be tuned either by inserting a chip coil in series with the feed point or adding a PCB track to the opposite end to match the resonant frequency to 2.44 GHz. The antenna must be tuned for the specific PCB with the ground plane size and enclosure that the final product has. The following chapter shows an example using the Johanson 2450AT42A100 chip antenna.

9.4.1 Johanson 2450AT42A100 antenna example

The following example shows the Johanson chip antennas placed in the two PCB corners. The 2450AT42A100 type is chosen for this purpose. Simplified PCB models are created using the Ansys Electronics Desktop tool. Figure 43 shows a 3D created model with two chip antennas. The aim of the example is to show that even the manufactured chip antenna needs specific tuning to achieve better antenna matching and radiation.

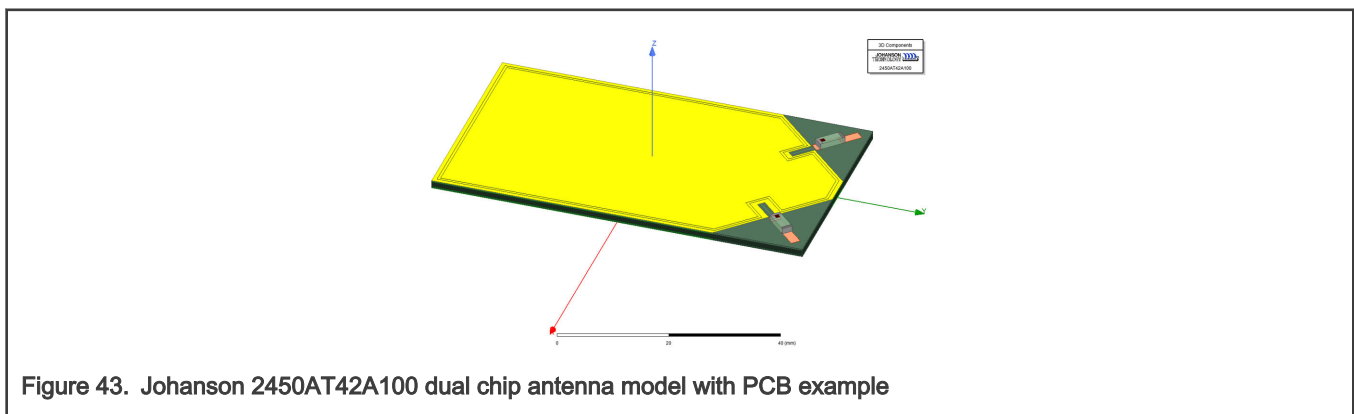

Johanson recommends no ground plane below the antenna part. The substrate material and thickness corresponds to the board stackup in the figure below. The example uses a four-layer design.

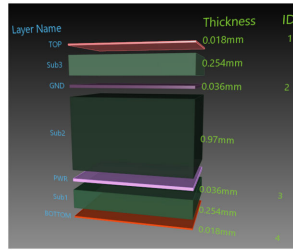

Figure 44. Chip antenna PCB board stackup

The commonly used FR4 material is chosen as a substrate. It has relative permittivity in the range of 4.3 – 4.5.

9.4.2 Johanson 2450AT42A100 reflection coefficient simulation results

This chapter shows the chip antenna simulated results of the reflection coefficient together with impedance and VSWR. Firstly, those antennas were simulated without any external matching components. Figure 45 displays the chip antennas reflection coefficient. It shows the antenna resonant frequency shifted at the 2.37 GHz. The minimum value (-12.7 dB) of the reflection coefficient might be lower.

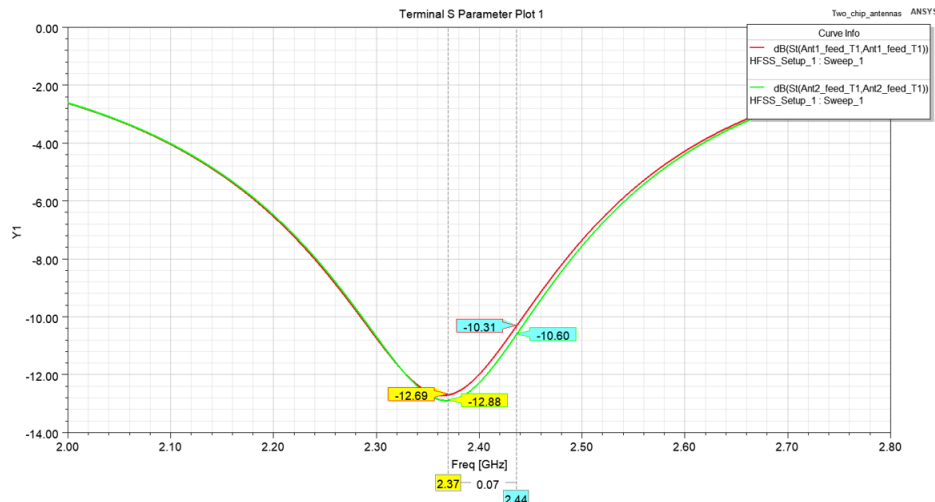

Figure 45. Chip antenna reflection coefficient – before matching

The Smith chart corresponding to that situation is in Figure 48. If the matching circuit is inserted before the chip antenna, it may bring some improvement. The example of the matching circuit tuned for the current chip antenna and PCB ground plane size is shown in Figure 46. It consists of one capacitor and one inductor for each antenna.

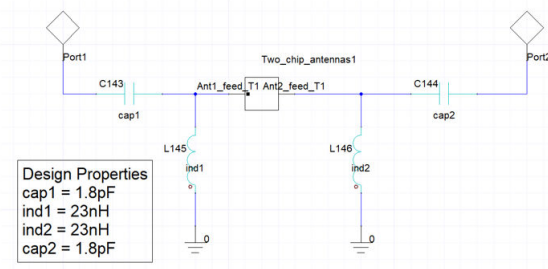

Figure 46. Example of the chip antenna matching circuit

The reflection coefficient improvement is shown in [Figure 47](#). There are changes in the resonant frequency and the lowest values achieve approximately -45 dB. The frequency shift was removed and both chip antennas resonate at 2.44 GHz. The frequency bandwidth where the chip antennas work with good matching is approximately 170 MHz.

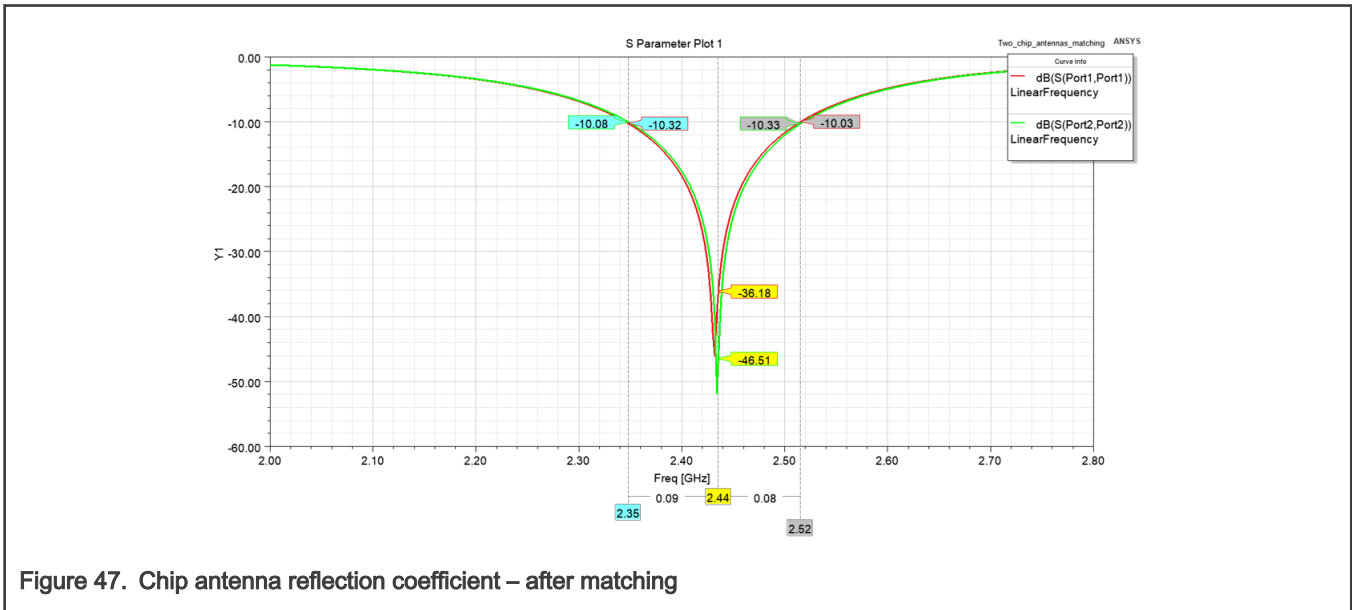

Figure 47. Chip antenna reflection coefficient – after matching

The appropriate Smith charts diagram after the matching circuit usage for both chip antennas is shown in [Figure 49](#). Both curves cross the value of 1 at 2.44 GHz.

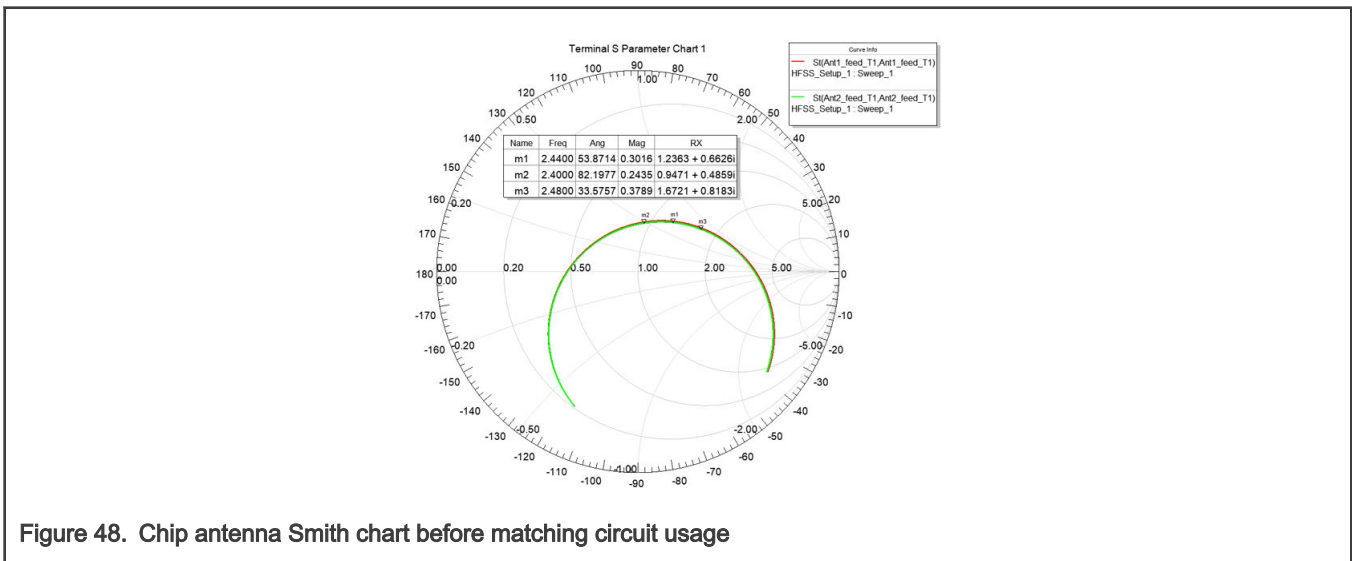

Figure 48. Chip antenna Smith chart before matching circuit usage

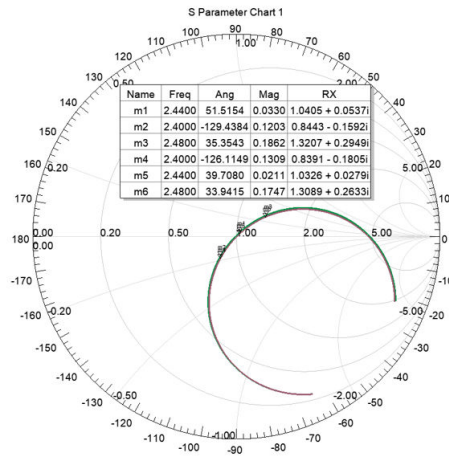

Figure 49. Chip antenna Smith chart after matching circuit usage

The chip antenna impedance and the VSWR chart are shown in Figure 50 and Figure 51. Both graphs confirm good antenna matching and its impedance values.

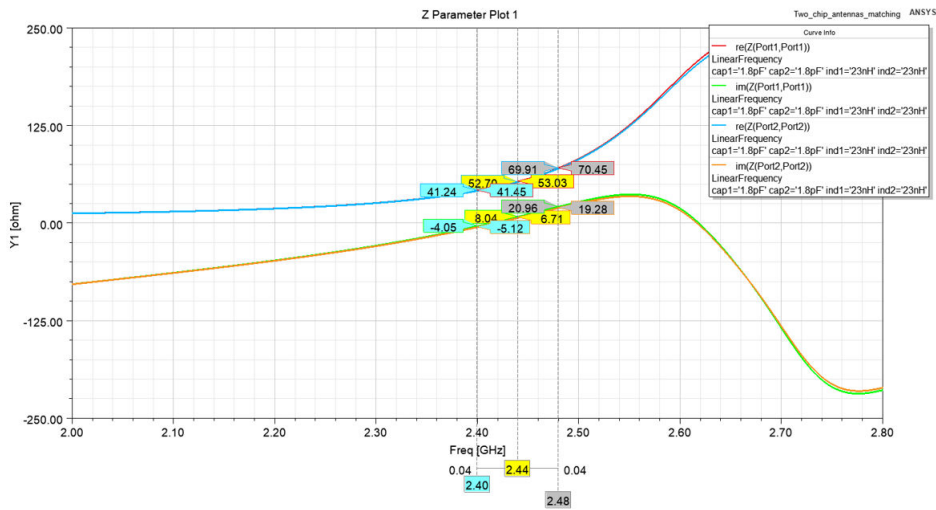

Figure 50. Johanson 2450AT42A100 chip antenna – impedance after matching

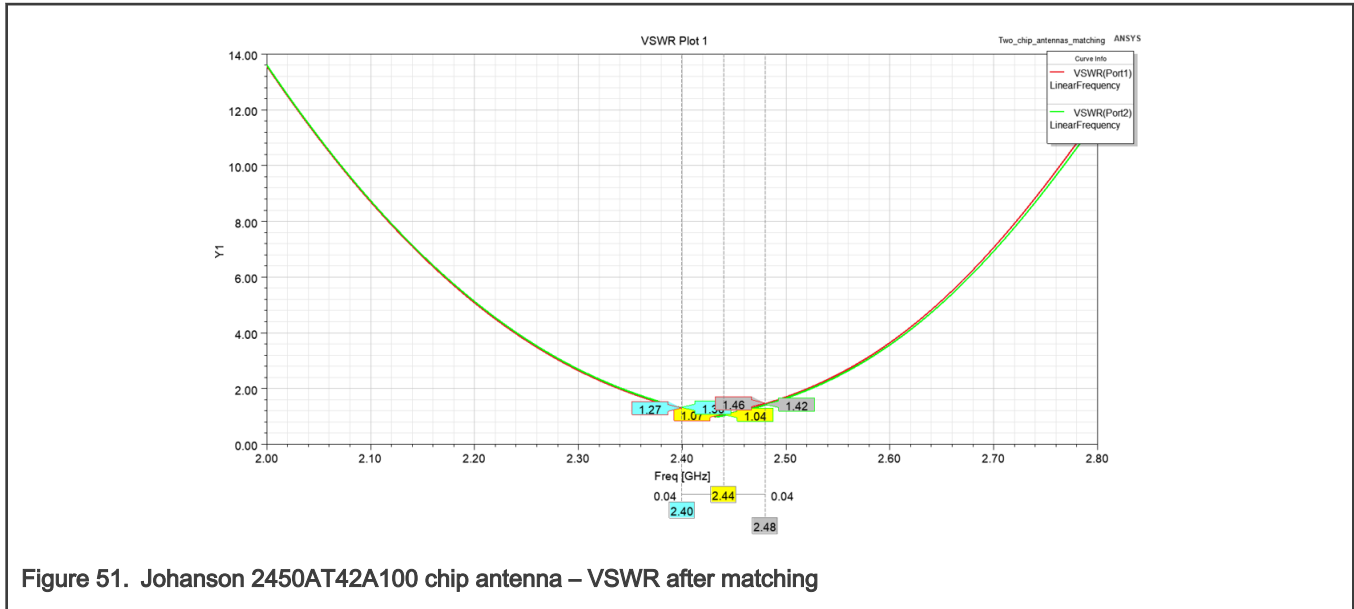

Figure 51. Johanson 2450AT42A100 chip antenna – VSWR after matching

The VSWR values below number 2 are considered a good result. The 2.4 GHz frequency shows the VSWR value of 1.3. The 2.48 GHz frequency shows the VSWR value of 1.45.

9.4.3 Johanson 2450AT42A100 radiation pattern simulation results

Figure 52 and Figure 53 display the PCB board with the 3D radiation pattern of both chip antennas. The red color represents the maximum radiation intensity.

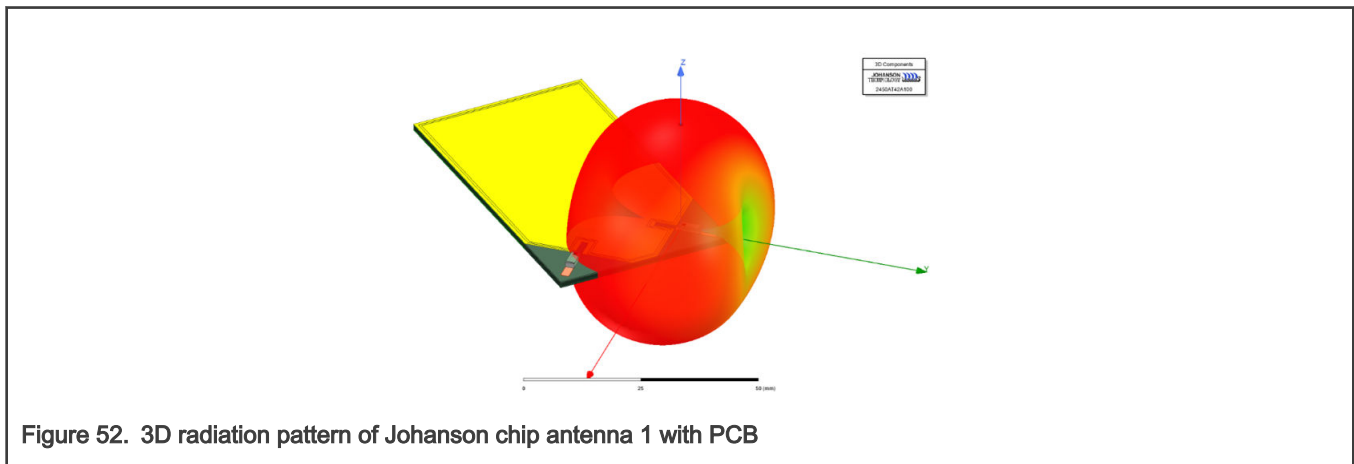

Figure 52. 3D radiation pattern of Johanson chip antenna 1 with PCB

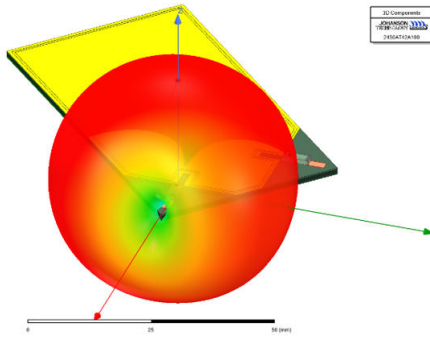

Figure 53. 3D radiation pattern of Johanson chip antenna 2 with PCB

Figure 54 and Figure 55 show the 3D radiation pattern with the appropriate scale and all axes. The maximum antenna gain is around -0.6 dBi. The datasheet of the Johanson 2450AT42A100 chip antenna claims the typical average gain of -1 dBi and its peak value of 0 dBi.

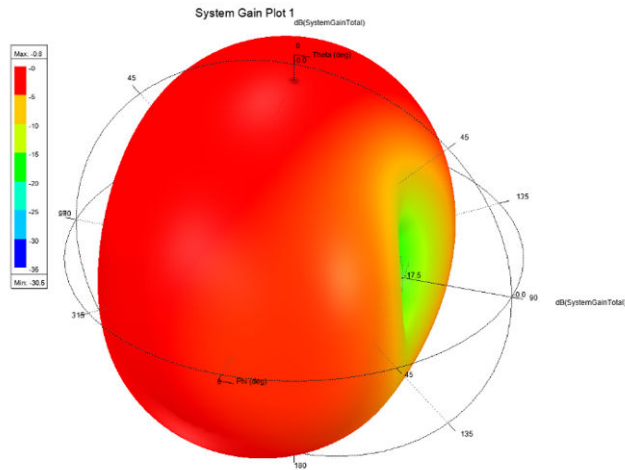

Figure 54. 3D gain radiation pattern of antenna 1 including axes

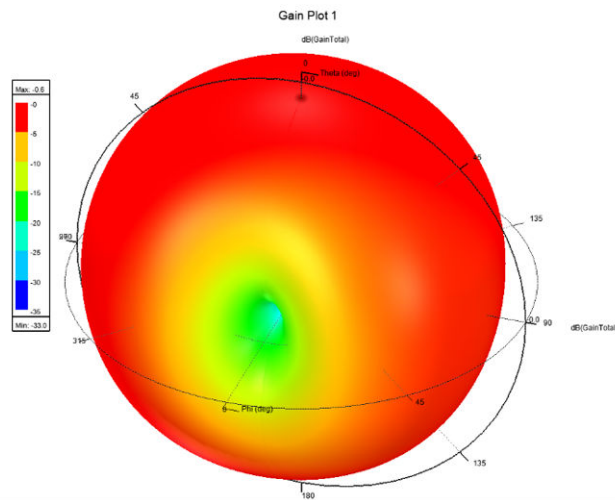

Figure 55. 3D gain radiation pattern of antenna 2 including axes

Figure 56 and Figure 57 show polar graphs with 2D radiation patterns using the most important cross-sections (in the ϕ axis) for both antennas.

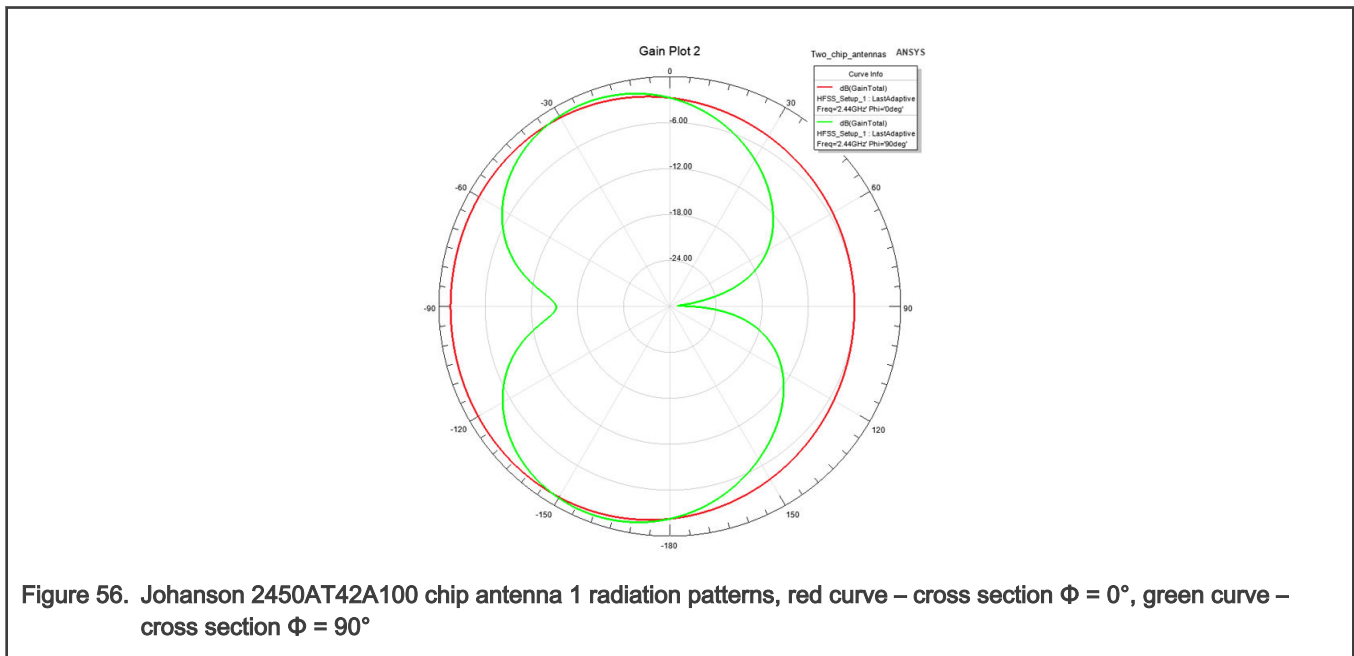

Figure 56. Johanson 2450AT42A100 chip antenna 1 radiation patterns, red curve – cross section $\Phi = 0^\circ$, green curve – cross section $\Phi = 90^\circ$

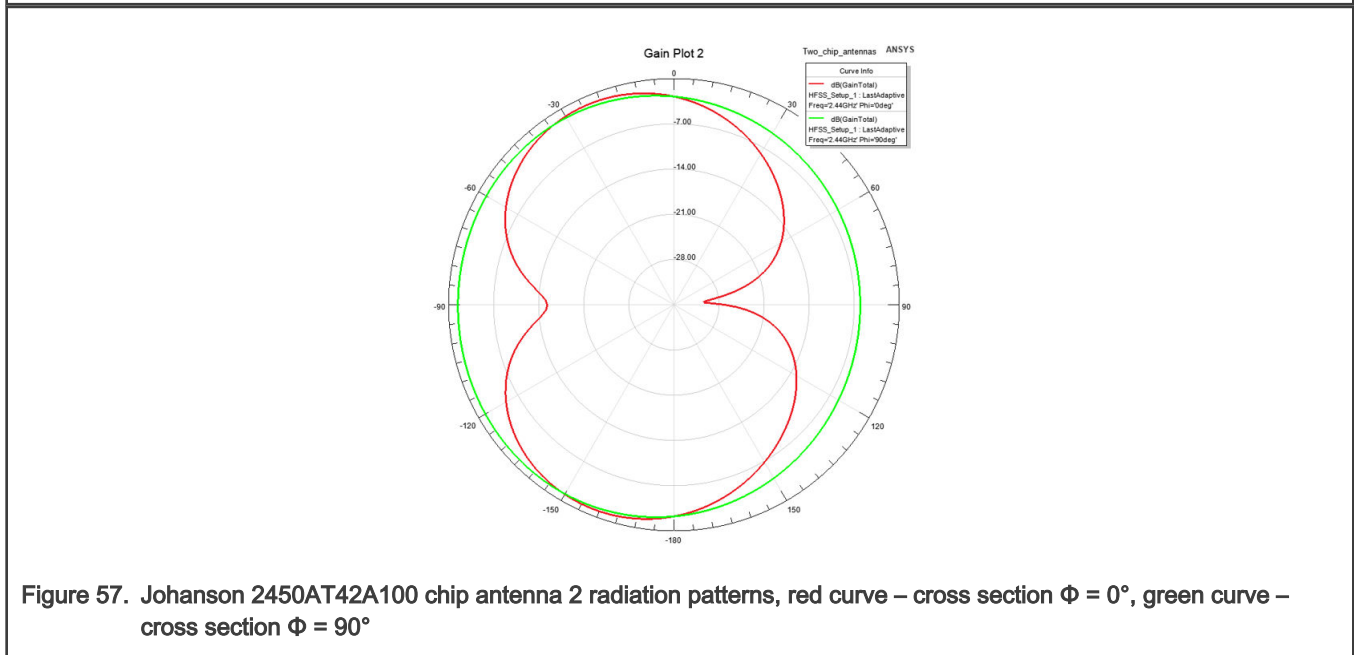

Figure 57. Johanson 2450AT42A100 chip antenna 2 radiation patterns, red curve – cross section $\Phi = 0^\circ$, green curve – cross section $\Phi = 90^\circ$

10 Other antenna designs (custom made)

The NXP wireless MCUs are designed for use in the nodes of low-power wireless networks based on the IEEE 802.15.4 or Bluetooth low energy protocol standards. These networks may employ higher level networking protocols built on top of IEEE 802.15.4, such as ZigBee PRO or ZigBee-RF4CE. The antenna is always an important part of the design and must be selected properly. This chapter describes the following three custom made designs for a suitable PCB antenna:

- Meander antenna
- Inverted-F Antenna (IFA)
- Dipole antenna

10.1 Meander antenna

The meander antenna simulations were done using ADS from Cadence and EMPro from Agilent as a two-layer printed antenna. The material properties were:

- Substrate FR4
- Substrate thickness = 1.0 mm
- Relative permittivity $\epsilon_r = 4.6$
- Dissipation factor $\tan(\delta) = 0.01$
- Copper thickness = 17 μm

10.1.1 Meander antenna layout

The meander antenna layout is shown [Figure 58](#).

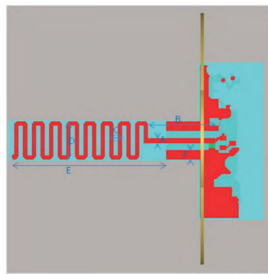

Figure 58. Meander antenna layout diagram

[Table 2](#) shows the meander antenna dimensions.

Table 2. Antenna dimensions

Reference (in diagram)	Distance (mm)
A	0.5
B	7.7
C	1.6
D	4.5
E	17.7
F	1.1

The whole antenna concept contains also a counter poise. The counter poise is made of a metallic tin plate 0.3 mm thick. The 3D model is shown in the figures below.

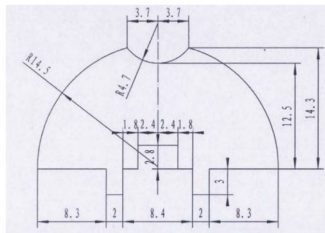

Figure 59. Counter poise dimensions

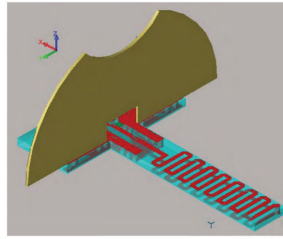

Figure 60. 3D view of meander antenna with its counter poise

10.1.2 Meander antenna simulation results

The reflection coefficient S11 is displayed in Figure 61. The following three markers show the resulting values:

- S11[2.350 GHz] = -4.31 dB
- S11[2.400 GHz] = -4.51 dB
- S11[2.510 GHz] = -4.6 dB

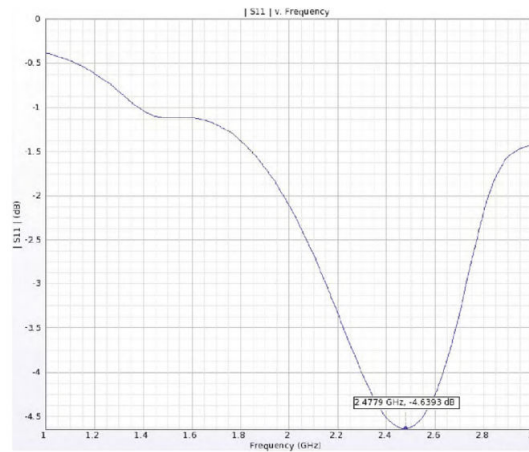

Figure 61. Reflection coefficient S11

The Smith chart shows the simulated results of the S11 reflection coefficient including the meander antenna impedance.

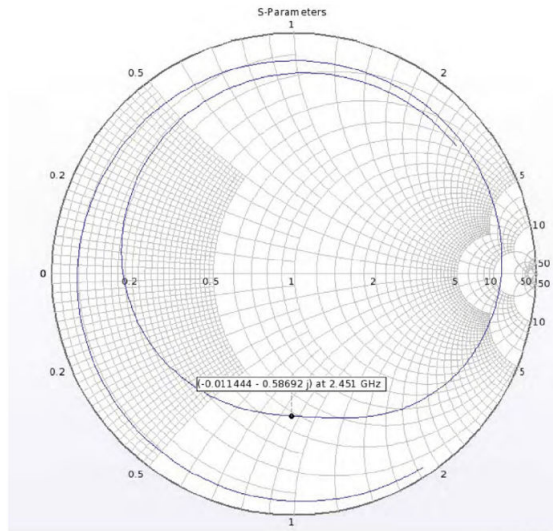

Figure 62. S11 Smith chart

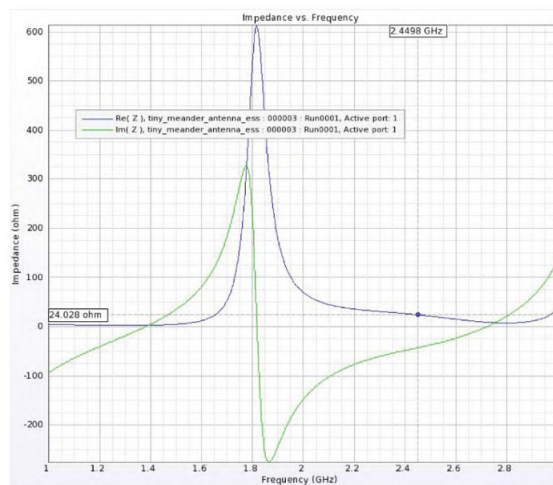

Figure 63. Impedance chart

The 3D radiation pattern shows the maximum gain in the θ direction.

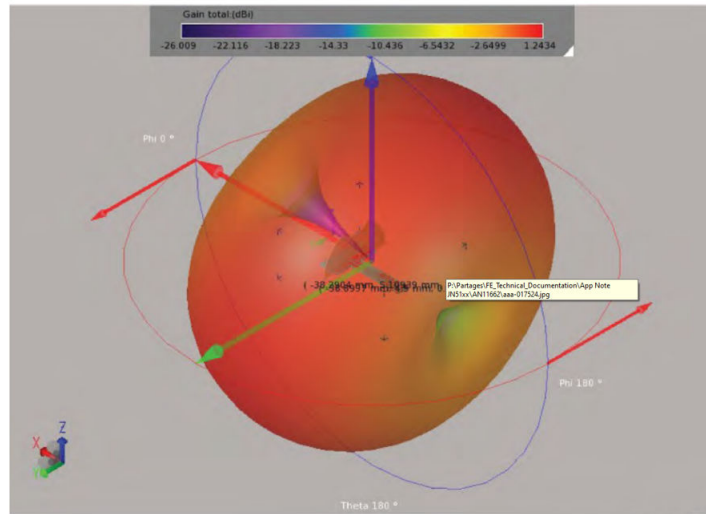

Figure 64. Total gain for all directions

The maximum gain of 1.2 dBi at 13° is shown in Figure 65.

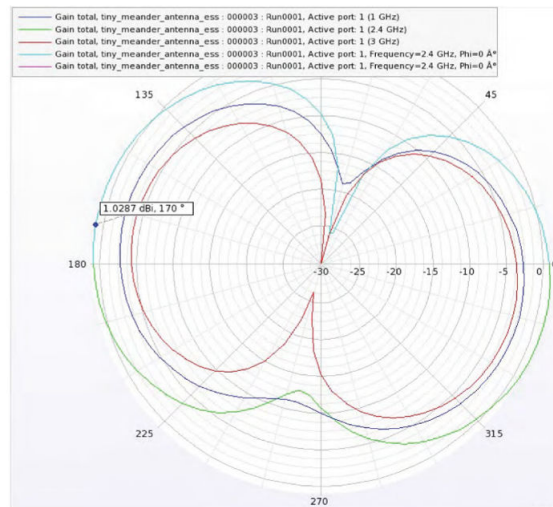

Figure 65. Gain in θ direction

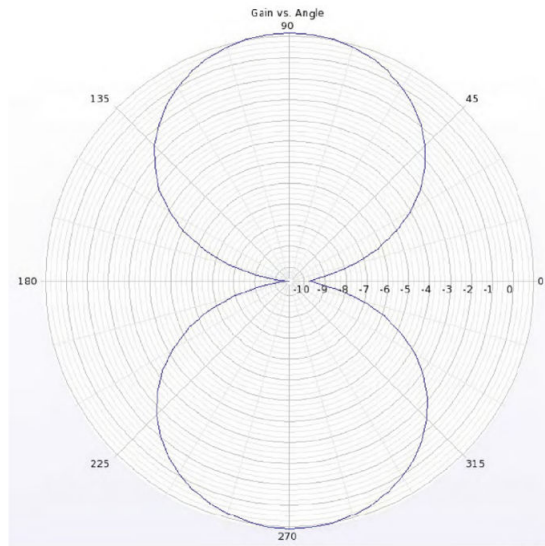

Figure 66. Gain in ϕ direction

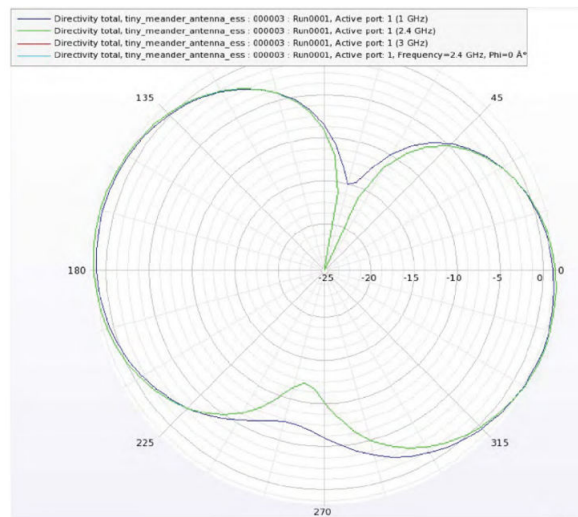

Figure 67. Directivity versus θ

Table 3 summarizes the meander antenna radiation efficiency at several frequencies.

Table 3. Radiation efficiency at 1 GHz, 2.4 GHz, and 3 GHz

Frequency	Efficiency
1 GHz	40.6 %
2.4 GHz	87.1 %
3 GHz	28.2 %

10.2 Inverted-F Antenna (IFA)

The IFA simulations were done with ADS from Cadence as a one-layer printed antenna. The PCB material characteristic were:

- Substrate FR4

- Substrate thickness = 1.6 mm
- Relative permittivity $\epsilon_r = 4.6$
- Dissipation factor $\tan(\delta) = 0.01$
- Copper thickness = 35 μm

10.2.1 IFA layout

The IFA layout is shown in [Figure 68](#).

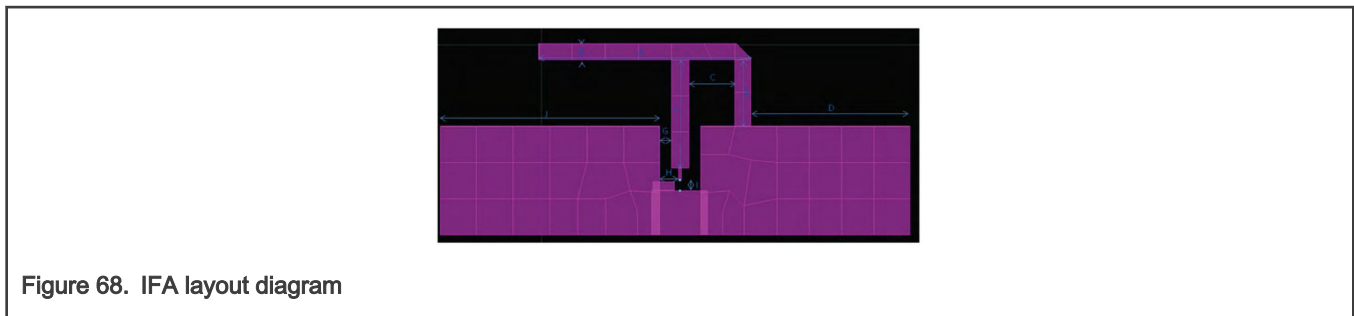

Figure 68. IFA layout diagram

[Table 4](#) shows the IFA dimensions.

Table 4. IFA layout dimensions

Reference (in diagram)	Distance (mm)
A	1.5
B	20.3
C	4.4
D	15.2
E	6.3
F	10.3
G	1.145
H	1.85
I	1.05
J	21

10.2.2 IFA simulation results

The reflection coefficient S11 is displayed in the graph below. The following three markers show the resulting values:

- S11[2.366 GHz] = - 19.6 dB
- S11[2.447 GHz] = - 19.8 dB
- S11[2.551 GHz] = - 44.9 dB

The Smith chart shows the simulated results of the S11 reflection coefficient.

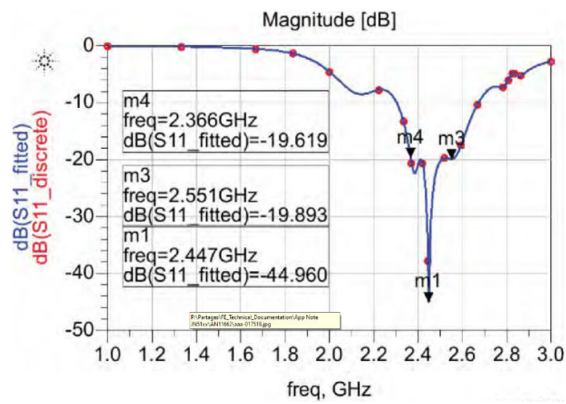

Figure 69. Reflection coefficient S11

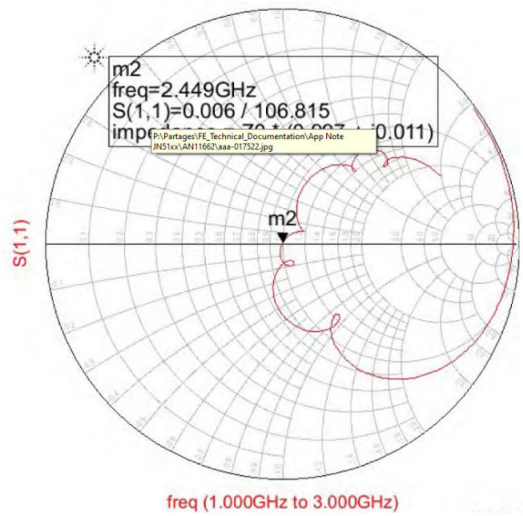

Figure 70. S11 Smith chart

The 3D radiation pattern shows the maximum gain in the θ direction.

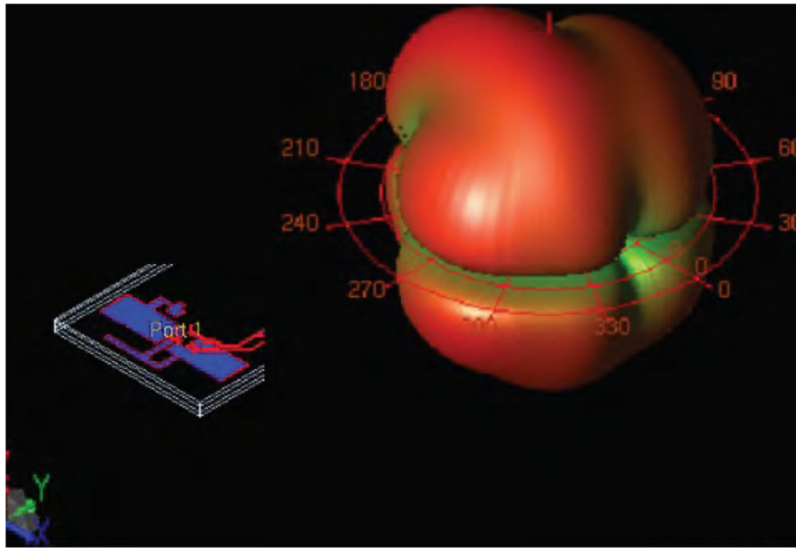

Figure 71. Total gain for all directions

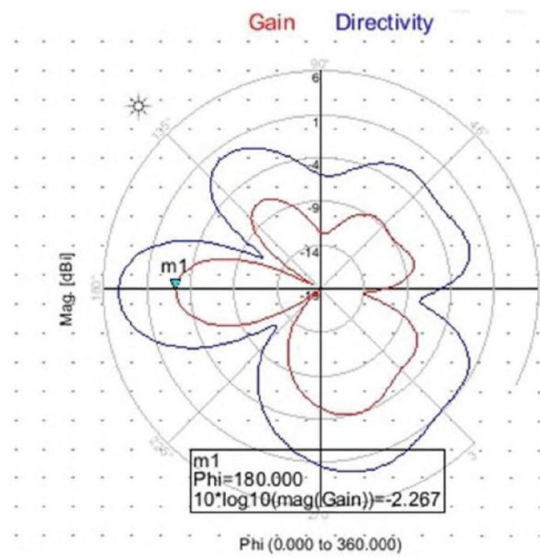

Figure 72. Gain in θ direction

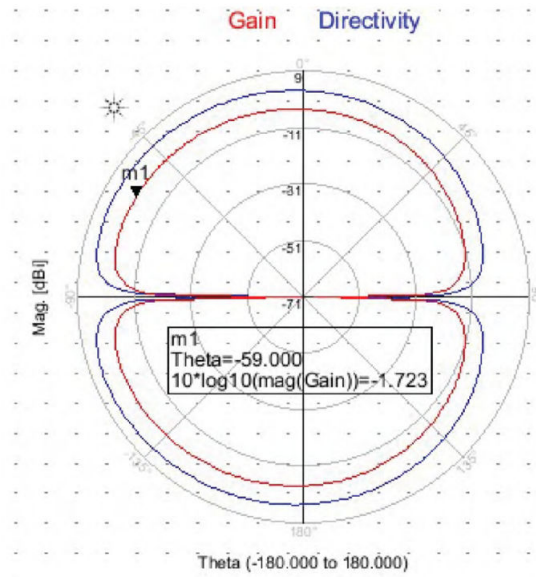

Figure 73. Gain in ϕ direction

Table 5 summarizes the IFA radiation efficiency at several frequencies.

Table 5. Radiation efficiency at 1 GHz, 2.4 GHz, and 3 GHz

Frequency	Efficiency
1 GHz	18 %
2.4 GHz	25 %
3 GHz	20.1 %

10.3 Dipole antenna

The dipole antenna simulations were done with ADS from Cadence as a one-layer printed antenna. The PCB material characteristic were:

- Substrate FR4
- Substrate thickness = 1.6 mm
- Relative permittivity $\epsilon_r = 4.6$
- Dissipation factor $\tan(\delta) = 0.01$
- Copper thickness = 35 μm

10.3.1 Dipole antenna layout

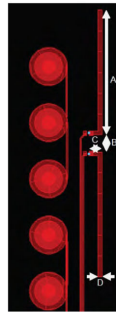

Figure 74. Dipole antenna layout diagram

Table 6. Dipole antenna layout dimensions

Reference (in diagram)	Distance (mm)
A	22.2
B	3
C	2.2
D	0.7

10.3.2 Dipole antenna simulation results

The reflection coefficient S22 is displayed in the graph below. The following three markers show the resulting values:

- S22 [2.367 GHz] = - 3 dB
- S22 [2.426 GHz] = - 5.8 dB
- S22 [2.547 GHz] = - 1.5 dB

The Smith chart shows the simulated results of the S22 reflection coefficient.

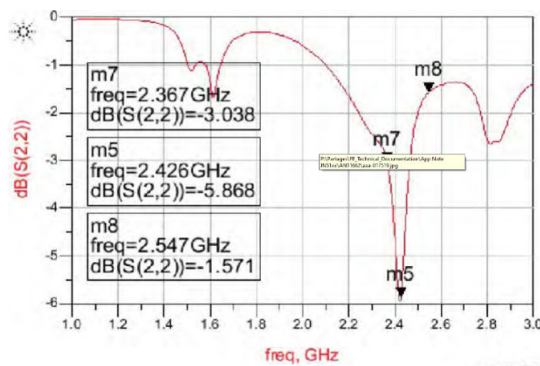

Figure 75. Reflection coefficient S22

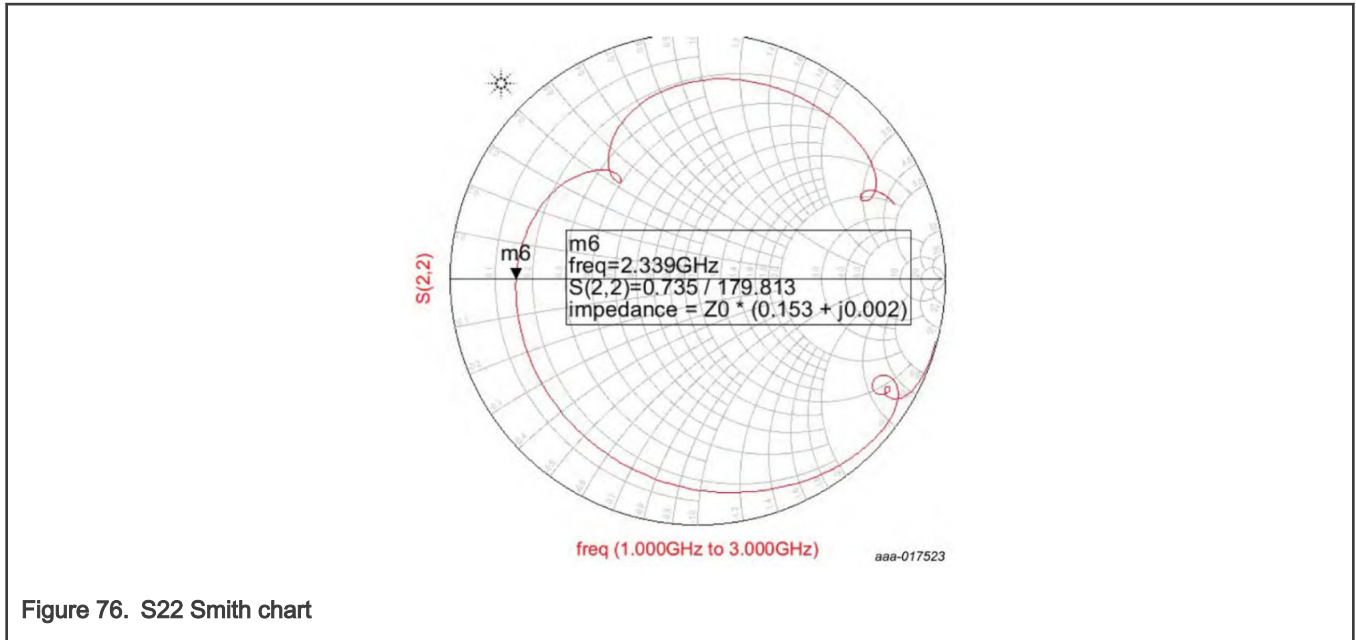

Figure 76. S22 Smith chart

The 3D radiation pattern shows the maximum gain in the θ direction.

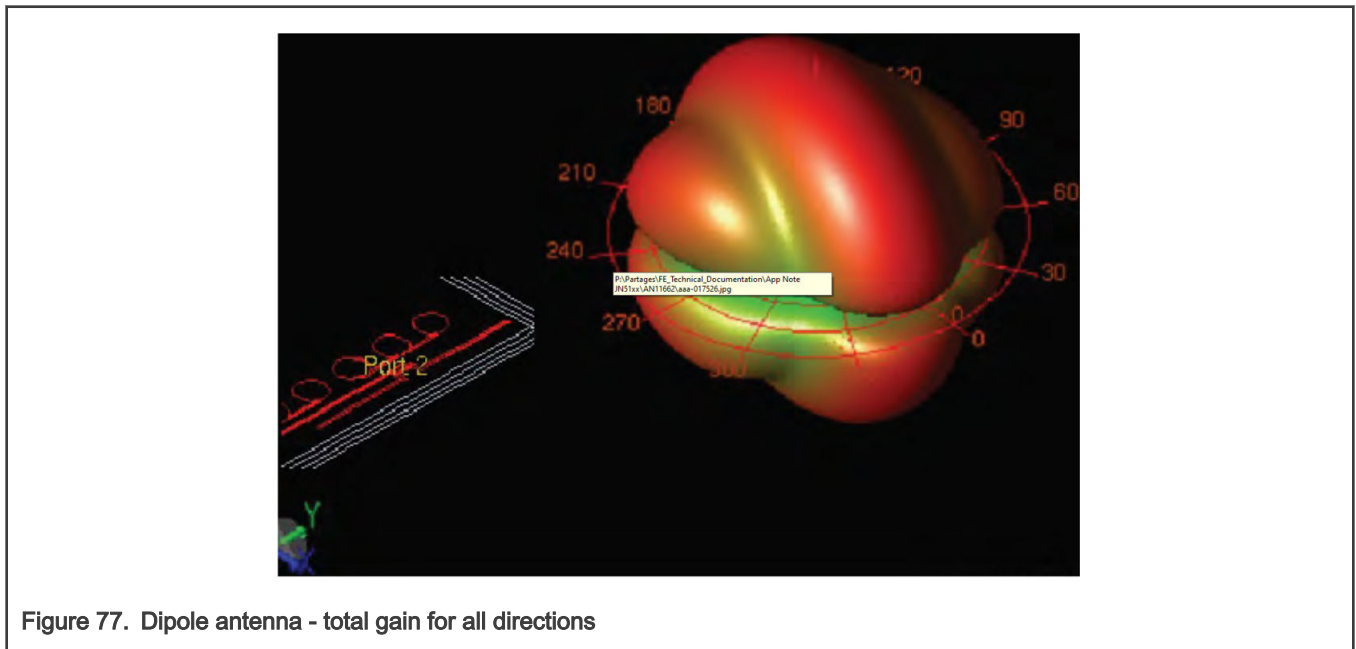

Figure 77. Dipole antenna - total gain for all directions

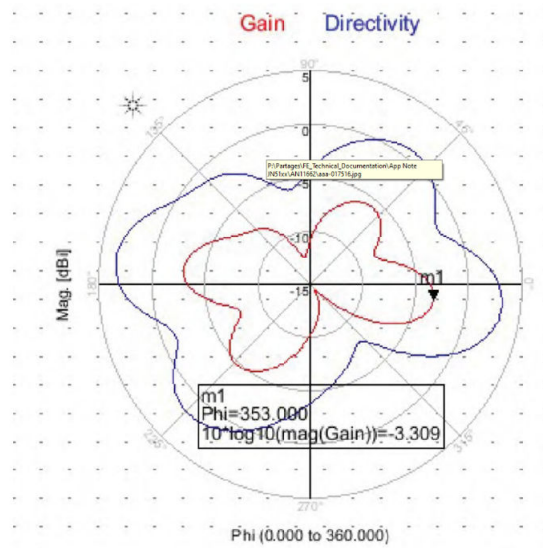

Figure 78. Gain in θ direction

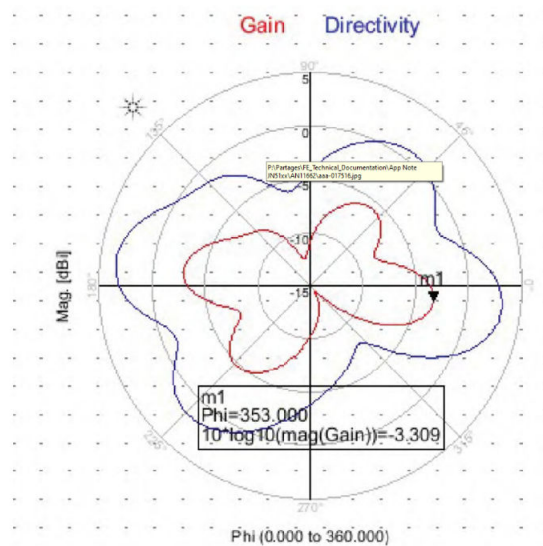

Figure 79. Gain in ϕ direction

Table 7 summarizes the dipole antenna radiation efficiency at several frequencies:

Table 7. Radiation efficiency at 1 GHz, 2.4 GHz, and 3 GHz

Frequency	Efficiency
1 GHz	26 %
2.4 GHz	22.54 %
3 GHz	41.8 %

11 Conclusion

This document summarizes basic antenna terms with the antenna theory description. The antenna matching was also mentioned and described. Several real antenna realizations were simulated and measured. Results were discussed and compared.

[Table 8](#) concludes the pros and cons of the mentioned antennas in the terms of size, gain, and directivity.

Table 8. Antenna dimensions

Antenna type	Size	Gain	Omni-directional
Quarter-wave monopole antenna	-	-	++
Inverted-F Antenna (IFA)	+	+	+
Meandered Planar Inverted-F Antenna (PIFA)	++	-	+
Chip antenna	++	++	-
Patch antenna	-	++	-
Dipole antenna	-	-	++
Meander antenna	+	+	+

The document helps you to speed up the antenna selection process. An ideally chosen antenna should be specifically tuned for a given PCB and its parameters.

12 Revision history

[Table 9](#) summarizes the changes done to this document.

Table 9. Revision history

Revision number	Date	Substantive changes
3	02/2020	Added Revision history and updated Figure 3 . Updated the document look and feel.
4	11/2020	The whole document updated with respect to the new NXP EVK boards. New antenna design examples added.

How To Reach Us

Home Page:

nxp.com

Web Support:

nxp.com/support

Information in this document is provided solely to enable system and software implementers to use NXP products. There are no express or implied copyright licenses granted hereunder to design or fabricate any integrated circuits based on the information in this document. NXP reserves the right to make changes without further notice to any products herein.

NXP makes no warranty, representation, or guarantee regarding the suitability of its products for any particular purpose, nor does NXP assume any liability arising out of the application or use of any product or circuit, and specifically disclaims any and all liability, including without limitation consequential or incidental damages. "Typical" parameters that may be provided in NXP data sheets and/or specifications can and do vary in different applications, and actual performance may vary over time. All operating parameters, including "typicals," must be validated for each customer application by customer's technical experts. NXP does not convey any license under its patent rights nor the rights of others. NXP sells products pursuant to standard terms and conditions of sale, which can be found at the following address: nxp.com/SalesTermsandConditions.

While NXP has implemented advanced security features, all products may be subject to unidentified vulnerabilities. Customers are responsible for the design and operation of their applications and products to reduce the effect of these vulnerabilities on customer's applications and products, and NXP accepts no liability for any vulnerability that is discovered. Customers should implement appropriate design and operating safeguards to minimize the risks associated with their applications and products.

NXP, the NXP logo, NXP SECURE CONNECTIONS FOR A SMARTER WORLD, COOLFLUX, EMBRACE, GREENCHIP, HITAG, ICODE, JCOP, LIFE VIBES, MIFARE, MIFARE CLASSIC, MIFARE DESFire, MIFARE PLUS, MIFARE FLEX, MANTIS, MIFARE ULTRALIGHT, MIFARE4MOBILE, MIGLO, NTAG, ROADLINK, SMARTLX, SMARTMX, STARPLUG, TOPFET, TRENCHMOS, UCODE, Freescale, the Freescale logo, AltiVec, CodeWarrior, ColdFire, ColdFire+, the Energy Efficient Solutions logo, Kinetis, Layerscape, MagniV, mobileGT, PEG, PowerQUICC, Processor Expert, QoriQ, QoriQ Qonverge, SafeAssure, the SafeAssure logo, StarCore, Symphony, VortiQa, Vybrid, Airfast, BeeKit, BeeStack, CoreNet, Flexis, MXC, Platform in a Package, QUICC Engine, Tower, TurboLink, EdgeScale, EdgeLock, eIQ, and Immersive3D are trademarks of NXP B.V. All other product or service names are the property of their respective owners. AMBA, Arm, Arm7, Arm7TDMI, Arm9, Arm11, Artisan, big.LITTLE, Cordio, CoreLink, CoreSight, Cortex, DesignStart, DynamIQ, Jazelle, Keil, Mali, Mbed, Mbed Enabled, NEON, POP, RealView, SecurCore, Socrates, Thumb, TrustZone, ULINK, ULINK2, ULINK-ME, ULINK-PLUS, ULINKpro, μ Vision, Versatile are trademarks or registered trademarks of Arm Limited (or its subsidiaries) in the US and/or elsewhere. The related technology may be protected by any or all of patents, copyrights, designs and trade secrets. All rights reserved. Oracle and Java are registered trademarks of Oracle and/or its affiliates. The Power Architecture and Power.org word marks and the Power and Power.org logos and related marks are trademarks and service marks licensed by Power.org.

© NXP B.V. 2020.

All rights reserved.

For more information, please visit: <http://www.nxp.com>

For sales office addresses, please send an email to: salesaddresses@nxp.com

Date of release: 11/2020

Document identifier: AN2731

